

# 36-Inch Column Freezer



**DRZ36980LAP/DA** — Panel ready, left hinge  
**DRZ36980RAP/DA** — Panel ready, right hinge

## Features & Benefits

- SteelCool™ full stainless steel interior
- LED 3D Lighting
- Hidden Touch Control Panel with SmartThings Wi-Fi connectivity
- Push-to-Open Door
- Dual Icemaker with Cocktail Ice™
- R600a refrigerant
- Panel ready

## Weights & Dimensions

<b>NET WEIGHT (LBS)</b>	580
<b>SHIPPING WEIGHT (LBS)</b>	608
<b>PRODUCT DIMENSIONS (W X H X D IN INCHES)</b>	35 3/4 x 83 3/8 x 25
<b>FLUSH CUTOUT REQUIRED (W X H X D IN INCHES)</b>	36 x 84 x 25

## Technical Details

<b>ELECTRICAL REQUIREMENTS</b>	115V, 60 Hz, 15A
--------------------------------	------------------

## Warranty

<b>FULL COVERAGE</b>	2 years
<b>SEALED SYSTEM, PARTS &amp; LABOR</b>	6 years
<b>SEALED SYSTEM, PARTS ONLY (COMPRESSOR INCLUDED)</b>	10 years

## Controls

<b>CONTROL TYPE</b>	Easy reach hidden Glass-Touch
<b>WI-FI + SMARTTHINGS</b>	Yes
<b>SABBATH MODE</b>	Yes

## Features

<b>TOTAL CAPACITY (CU. FT.)</b>	21.4
<b>PUSH-TO-OPEN</b>	Yes
<b>WATER DISPENSER</b>	Internal water dispenser
<b>ICEMAKER</b>	Dual Icemaker with Cocktail Ice™
<b>DEODORIZING FILTER</b>	Yes
<b>LED LIGHTING</b>	3D Lighting
<b>INTERIOR MATERIAL</b>	SteelCool™ (Full stainless steel walls)
<b>DIGITAL INVERTER COMPRESSOR</b>	Yes
<b>REFRIGERANT</b>	R600a
<b>FREEZER DRAWERS</b>	2
<b>DOOR BINS</b>	4
<b>SHELVES</b>	4
<b>DOOR ALARM</b>	Yes

## Refrigerator

<b>FRESHZONE™ DRAWER</b>	Yes
--------------------------	-----

## Freezer

<b>FREEZER CAPACITY (CU. FT.)</b>	21.4
<b>FREEZER TEMPERATURE</b>	-8°F to 5°F
<b>DEDICATED EVAPORATOR &amp; COMPRESSOR SYSTEM</b>	Yes
<b>POWER FREEZE</b>	Yes

## Accessories (Optional)

Please see page 12 of Reference Guide for a full list of accessories

<b>RAC36AMLHSR/DA</b>	36" panel kit, Silver Stainless, left
<b>RAC36AMRHSR/DA</b>	36" panel kit, Silver Stainless, right
<b>RAC36AMLHMS/DA</b>	36" panel kit, Graphite Stainless, left
<b>RAC36AMRHMS/DA</b>	36" panel kit, Graphite Stainless, right
<b>RACOOWFAAAA/DA</b>	Water filter for refrigeration
<b>RACOOTCAAAA</b>	Install kit for triple built-in refrigeration
<b>RACOOCPAAAA/DA*</b>	Install kit to pair built-in refrigeration

\*2x needed for triple install.

# 36-Inch Column Freezer



## Product Dimensions

<b>A - WIDTH (IN/MM)</b>	35 3/4 / 908
<b>B - WIDTH PANEL (IN/MM)</b>	25 / 635
<b>C - HEIGHT (IN/MM)</b>	83 3/8 / 2118
<b>D - (IN/MM)</b>	35 5/8 / 905
<b>D1 - WITH PANEL (IN/MM)</b>	36 7/8 / 936
<b>D2 - WITH MODERNIST HANDLE (IN/MM)</b>	36 - 39 3/8 / 1000
<b>E - (IN/MM)</b>	62 7/8 / 1597
<b>F - (IN/MM)</b>	20 9/16 / 496
<b>G - (IN/MM)</b>	61 5/16 / 1556

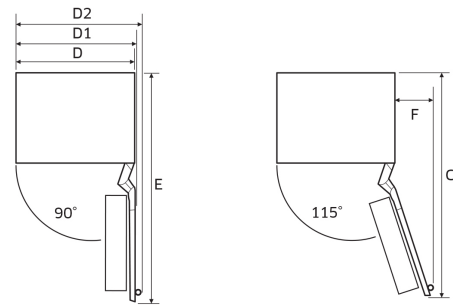
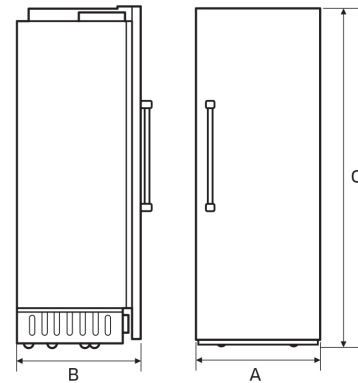

## Installation Cutout Dimensions

<b>A - WIDTH (IN/MM)</b>	36 / 914
<b>B - DEPTH (IN/MM)</b>	25 / 635
<b>C - HEIGHT (IN/MM)</b>	84 / 2134
<b>D - (IN/MM)</b>	26 / 660
<b>E - (IN/MM)</b>	80 / 2032

