



**INSTRUCTIONS D'ASSEMBLAGE**  
**ASSEMBLY INSTRUCTIONS**

---

**M**ONARCH  
SPECIALTIES INC.

# I 1158

---

**CHAISE -**  
**2PCS / 33"H / SIMILI-CUIR GRIS / METAL NOIR**

**DINING CHAIR -**  
**2PCS / 33"H / GREY LEATHER-LOOK / BLACK METAL**





**POUR DE L'ASSISTANCE OU POUR COMMANDER  
DES PIÈCES CONTACTEZ NOTRE DÉPARTEMENT  
DE SERVICE À LA CLIENTÈLE.**

**FOR ASSISTANCE OR TO ORDER PARTS  
CONTACT OUR CUSTOMER SERVICE DEPARTMENT**

**WWW.MONARCHSERVICE.COM**

**LISTE DES PIÈCES**  
**PARTS LIST**

PIÈCE / PART #	IMAGE	DESCRIPTION	QTY / QTÉ
1		<p>SEAT SIÈGE</p>	2
2		<p>CHAIR LEG (FRONT) PATTE DE CHAISE (AVANT)</p>	4
3		<p>CHAIR LEG PATTE DE CHAISE</p>	4

**LISTE DES PIÈCES DE MONTAGE**  
**HARDWARE LIST**

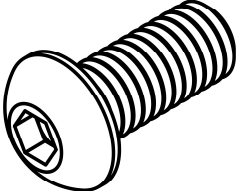
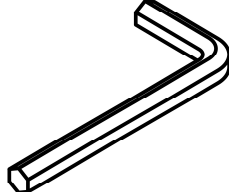
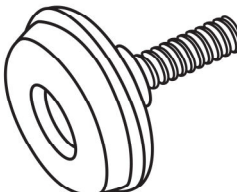
PIÈCE / PART #	IMAGE	DESCRIPTION	QTY / QTÉ
A		ASSEMBLING BOLT - Ø1/4" X 3/4" BOULON D'ASSEMBLAGE - Ø1/4" X 3/4"	24
B		HEX KEY CLÉ HEXAGONALE	1
C		ADJUSTABLE LEG PATTE AJUSTABLE	8



OUTIL DE VÉRIFICATION DE DIMENSIONS DES PIÈCES  
HARDWARE DIMENSIONS VERIFICATION TOOL



ÉTAPE / STEP 1

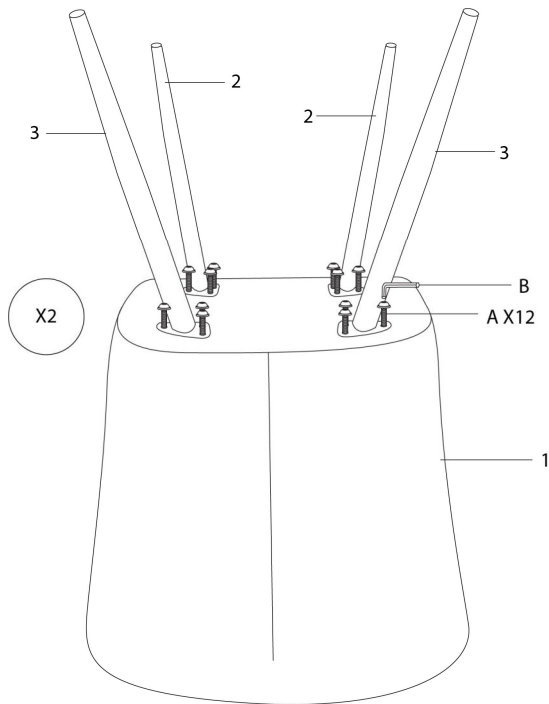

ÉTAPE / STEP 2

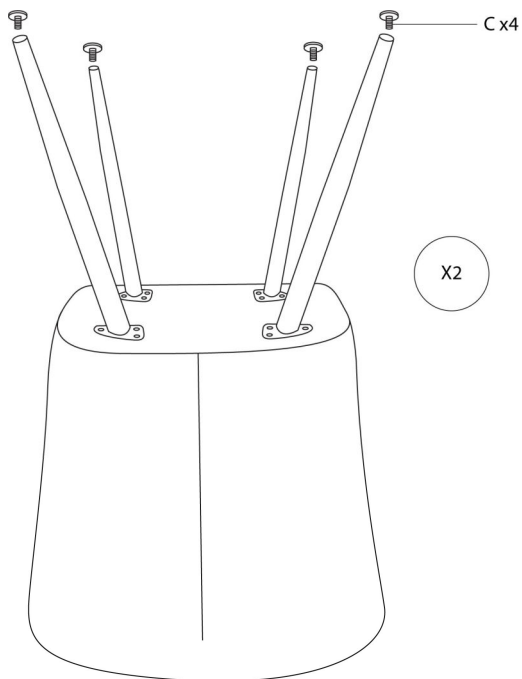

ÉTAPE / STEP 3

