



ASSEMBLY INSTRUCTIONS



B1248-071 LENNOX DOOR CHEST W/SHOE STORAGE & LED LIGHT

Thank you for purchasing this quality product. Be sure to check all packing materials carefully for small parts, which may have come loose inside the carton during shipment. Identify and count all items and compare with the parts list and/or hardware list shown.

PARTS LIST

NO	COMPONENT	DRAWING	QTY
A	Chest		1 pc
B	Leg		4 pcs

HARDWARE LIST

NO	COMPONENT	DRAWING	QTY
1	Anti-Tip Kit		1 pc
2	DC Adapter L.E.D		1 pc

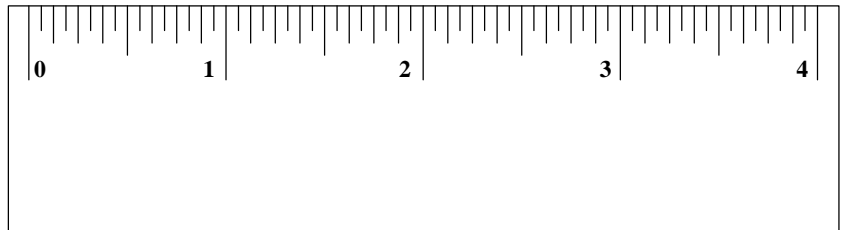

STEP 1 : Locate the Legs (B) from the bottom drawer of the Chest (A).

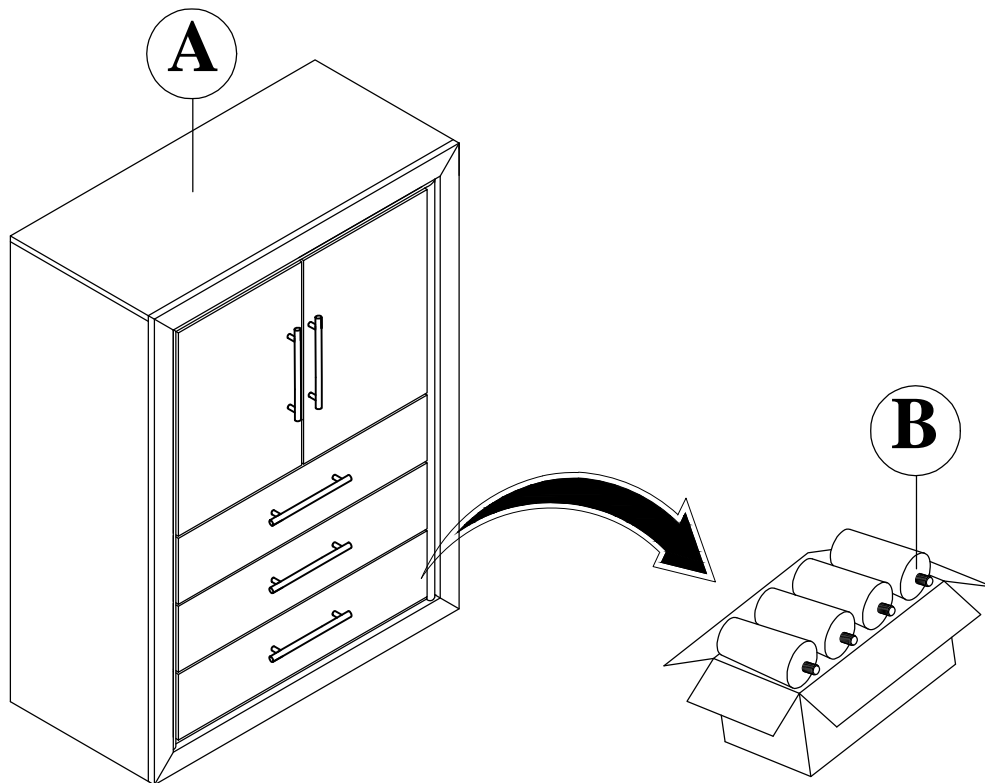

STEP 2 : Place the Chest (A) upside down on a clean and flat surface. Assemble the Leg (B) with Chest (A) by twisting each leg into the corresponding hole until securely tightened.

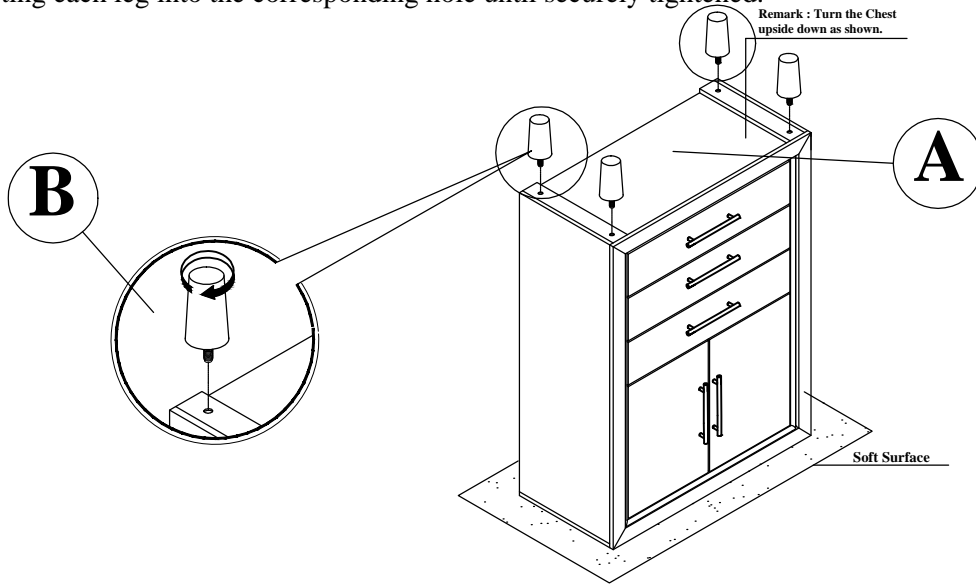

STEP 3 : Place the Chest (A) up right and connect the wire on the back of Chest (A) with the DC adapter (2).

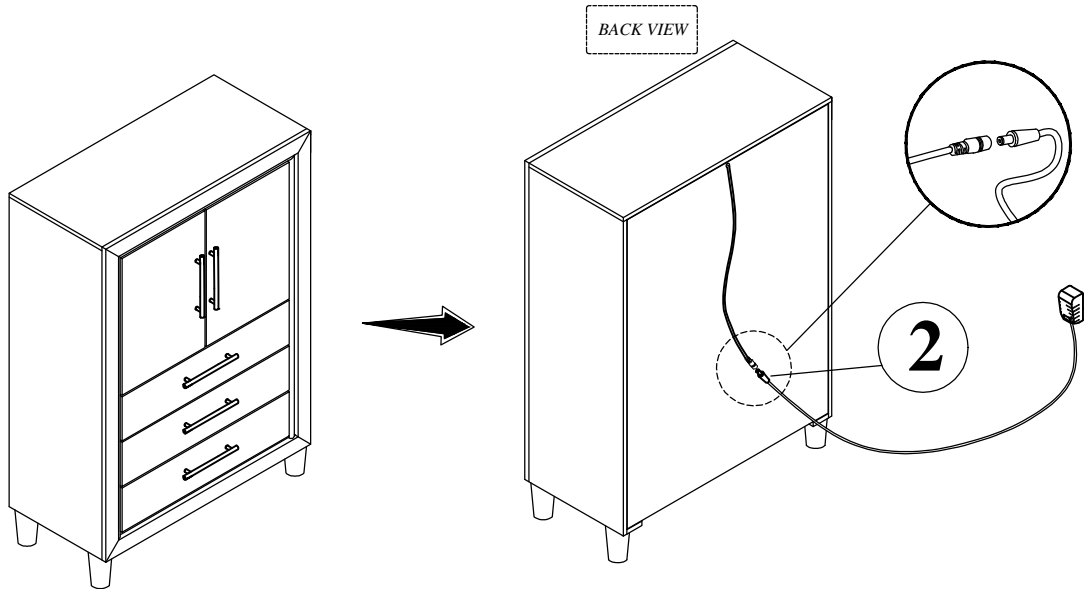

STEP 4 : Assembly the Anti-Tip Kit (1) to the Chest (A).

