

LG SIGNATURE

OWNER'S MANUAL MAIN WASHER

Read this owner's manual thoroughly before operating the appliance and keep it handy for reference at all times.

LUWM101HWA



MFL69475588

www.LGSIGNATURE.com

Copyright © 2017 LG Electronics Inc. All Rights Reserved.

TABLE OF CONTENTS

4 PRODUCT FEATURES

5 SAFETY INSTRUCTIONS

5 IMPORTANT SAFETY INSTRUCTIONS

9 PRODUCT OVERVIEW

9 Parts

9 Accessories

10 INSTALLATION

10 Installation Parts and Tools

10 Installation Overview

11 Product Specifications

12 Choosing the Proper Location

13 Unpacking and Removing Shipping Bolts

14 Connecting the Water Lines

15 Connecting the Drain Hose

16 Leveling the Washer

17 Connecting to the Power Supply

17 Testing the Washer

18 OPERATION

18 Using the Washer

19 Sorting Laundry

20 Loading the Washer

20 Adding Cleaning Products

23 Control Panel

24 Wash Cycles

26 Cycle Guide

29 Cycle Modifier Buttons

32 Special Cycles/Features

33 Drying Tips

35 Settings

39 Download Cycles

40 SMART FUNCTIONS

40 Smart ThinQ Application

42 Smart Diagnosis™ Function

43 MAINTENANCE

43 Regular Cleaning

45 Cleaning the Door Seal

45 Cleaning the Water Inlet Filters

46 Cleaning the Drain Pump Filter

47 Cleaning Auto Dispense Tray

48 Care in Cold Climates

49 TROUBLESHOOTING

49 FAQs: Frequently Asked Questions

50 Before Calling for Service

57 WARRANTY (USA)

PRODUCT FEATURES

INVERTER DIRECT DRIVE MOTOR

The inverter motor, which is directly connected to the tub, produces little noise and vibration and offers great durability and a long lifespan.

TUB CLEAN

Cleaning of the tub on a regular monthly basis using Tub Clean can help keep the tub clean and fresh.

LARGE CAPACITY STAINLESS STEEL DRUM

The large capacity stainless steel drum offers extreme durability and is tilted to improve efficiency and allow easier access for large items.

CONTROL LOCK

Use this option to disable the controls during a wash cycle. This option can prevent children from changing cycles or operating the machine.

AUTO DISPENSE

The detergent and softener are automatically dispensed based on the load size.

HIGH TEMPERATURE STEAM CYCLES (on some models)

LG's unique, high-temperature steam cycles help to remove tough stains.

SMART THINQ

Download the free Smart ThinQ application to a smartphone in order to remotely operate and communicate with the appliance, and to help diagnose problems.

SAFETY INSTRUCTIONS

READ ALL INSTRUCTIONS BEFORE USE

Your safety and the safety of others are very important.

We have provided many important safety messages in this manual and on your appliance. Always read and follow all safety messages.

This is the safety alert symbol.



This symbol alerts you to potential hazards that can kill or injure you and others.

All safety messages will follow the safety alert symbol and either the word WARNING or CAUTION.



WARNING

If you do not follow instructions, it could result in death or serious injury.



CAUTION

If you do not follow instructions, it could result in minor or moderate injury or damage to the product.

All safety messages will tell you what the potential hazard is, tell you how to reduce the chance of injury, and tell you what may happen if the instructions are not followed.

IMPORTANT SAFETY INSTRUCTIONS



WARNING

To reduce the risk of explosion, fire, death, electric shock, scalding or injury to persons when using this product, follow basic precautions, including the following:

California Safe Drinking Water and Toxic Enforcement Act

- This product contains chemicals known to the state of California to cause cancer and birth defects or other reproductive harm. ***Wash hands after handling.***

INSTALLATION

- Adhere to all industry recommended safety procedures including the use of long-sleeved gloves and safety glasses.
- Never attempt to operate this appliance if it is damaged, malfunctioning, partially disassembled, or has missing or broken parts, including a damaged cord or plug.
- Before use, the appliance must be properly installed as described in this manual.
- To reduce the risk of severe injury or death, follow all installation instructions.
- Refer to the INSTALLATION INSTRUCTIONS for detailed grounding procedures. Installation instructions are packed with the appliance for the installer's reference. If the appliance is moved to a new location, have it checked and reinstalled by qualified service personnel.
- The appliance must be installed and electrically grounded by qualified service personnel in accordance with local codes.
- Connect to a properly rated, protected, and sized power circuit to avoid electrical overload.
- This appliance must be positioned near to an electrical power supply.
- Disconnect the power cord, house fuse or circuit breaker before installing or servicing the appliance.
- When moving or installing the product in a different location, call qualified service personnel for installation and service.
- The power cord of this appliance is equipped with a 3-prong (grounding) plug which mates with a standard 3-prong (grounding) wall outlet to minimize the possibility of electric shock from this appliance.
- Do not, under any circumstances, cut or remove the third (ground) prong from the power cord.

- When installing or moving the appliance, be careful not to pinch, crush, or damage the power cord.
- Do not install the appliance in humid spaces.
- Keep packing materials out of the reach of children. Packaging material can be dangerous for children. There is a risk of suffocation.
- Destroy the carton, plastic bag, and other packing materials after the appliance is unpacked. Children might use them for play. Cartons covered with rugs, bedspreads, or plastic sheets can become airtight chambers.
- Moving or installation of the appliance requires two or more people.
- Store and install the appliance where it will not be exposed to temperatures below freezing or exposed to outdoor weather conditions.
- This appliance is not designed for maritime use or for mobile installations such as in RVs, trailers, or aircraft.

OPERATION

- Read all instructions before using the appliance and save these instructions.
- Use this appliance only for its intended purpose.
- Do not tamper with controls.
- Do not abuse, sit on, or stand on the door of the appliance.
- Do not allow children to play on, in or with the appliance. Close supervision of children is necessary when the appliance is used near children.
- Do not reach into the washer if the tub or drum, agitator, or any interior parts are moving. Before loading, unloading, or adding items, press Start/Pause and allow the tub or drum to coast to a complete stop before reaching inside.
- Do not mix chlorine bleach with ammonia or acids such as vinegar. Follow package directions when using laundry products. Incorrect usage can produce poisonous gas, resulting in serious injury or death.
- Never use harsh chemicals, abrasive cleaners, or solvents to clean the washer. They will damage the finish.
- Do not use an extension cord or adapter with this appliance.
- Repair or immediately replace all power cords that have become frayed or otherwise damaged. Do not use a cord that shows cracks or abrasion damage along its length or at either end.
- Do not grasp the power cord or touch the appliance controls with wet hands.
- Do not modify or extend the power cord.
- Do not wash articles that have been previously cleaned in, washed in, soaked in, or spotted with gasoline, dry-cleaning solvents, vegetable or cooking oil, or other flammable or explosive substances, as they give off vapors that could ignite or explode.
- In the event of a gas leak (propane gas, LP gas, etc.) do not operate this or any other appliance. Open a window or door to ventilate the area immediately.
- If the product has been submerged, contact an LG Electronics customer information center for instructions before resuming use.
- If you detect a strange sound, a chemical or burning smell, or smoke coming from the appliance, unplug it immediately, and contact an LG Electronics customer information center.
- Keep laundry products out of children's reach. To prevent injury to persons, observe all warnings on product labels.
- Do not use liquid chlorine bleach.
- Do not operate the appliance without the Auto Dispense tray in place.

- Under certain conditions, hydrogen gas may be produced in a hot-water system that has not been used for two weeks or more. **HYDROGEN GAS IS EXPLOSIVE.** If the hot-water system has not been used for such a period, before using the appliance turn on all hot water faucets and let the water flow from each for several minutes. This will release any accumulated hydrogen gas. As the gas is flammable, do not smoke or use an open flame during this time.
- Do not store or use gasoline or other flammable vapors and liquids in the vicinity of this or any other appliance.
- Do not add gasoline, dry cleaning solvents, or other flammable or explosive substances to the wash water. These substances give off vapors that could ignite or explode.
- Do not put oily or greasy clothing, candles or flammable materials on top of the appliance.
- Keep the area underneath and around your appliances free of combustible materials (lint, paper, rags, etc.), gasoline, chemicals and other flammable vapors and liquids.
- This appliance is not intended for use by persons (including children) with reduced physical, sensory or mental capabilities, or lack of experience and knowledge, unless they have been given supervision or instruction concerning the use of the appliance by a person responsible for their safety.
- If the electrical supply cord is damaged, it must only be replaced by the manufacturer or its service agent or a similar qualified person in order to avoid a hazard.
- Never unplug the appliance by pulling on the power cord. Always grip the plug firmly and pull straight out from the outlet.
- Fix the drain hose securely in place.
- Do not add gasoline, dry cleaning solvents, or other flammable or explosive substances to the wash water. These substances give off vapors that could ignite or explode.

MAINTENANCE

- Remove the door before the appliance is removed from service or discarded to avoid the danger of children or small animals getting trapped inside.
- Do not repair or replace any part of the appliance. All repairs and servicing must be performed by qualified service personnel unless specifically recommended in this owner's manual. Use only authorized factory parts.
- Remove any dust or foreign matter from the power plug pins.
- Disconnect this appliance from the power supply before cleaning and attempting any user maintenance. Turning the controls to the OFF position does not disconnect this appliance from the power supply.
- Make sure the door is closed at all times when not being filled with laundry products.
- Do not disassemble or repair the appliance by yourself.

GROUNDING INSTRUCTIONS

- Improper connection of the equipment-grounding conductor can result in a risk of electric shock. Check with a qualified electrician or service personnel if you are in doubt whether the appliance is properly grounded. Do not modify the plug provided with the appliance; if it will not fit the outlet, have a proper outlet installed by a qualified electrician.
- For your safety, the information in this manual must be followed to minimize the risk of fire, explosion, or electric shock, or to prevent property damage, injury to persons, or death.
- The appliance must be grounded. In the event of a malfunction or breakdown, grounding will reduce the risk of electric shock by providing a path of least resistance for electric current. The appliance is equipped with a cord having an equipment-grounding conductor and a grounding plug. The plug must be plugged into an appropriate outlet that is installed and grounded in accordance with all local codes and ordinances.

BASIC SAFETY PRECAUTIONS

- Do not dry unwashed items in the appliance.
- Unplug the appliance before cleaning to avoid the risk of electric shock.
- Items that have been soiled with substances such as cooking oil, vegetable oil, acetone, alcohol, petroleum, kerosene, spot removers, turpentine, waxes and wax removers should be washed in hot water with an extra amount of detergent before being dried in the appliance.
- Fabric softeners, or similar products, should be used as specified by the fabric softener instructions.
- Remove all objects from pockets such as lighters and matches.
- The appliance is not to be used if industrial chemicals have been used for cleaning.
- Certain internal parts are intentionally not grounded and may present a risk of electric shock only during servicing. Service personnel - Do not contact the following parts while the appliance is energized: pump, valve, motor, control board.

CAUTION

To reduce the risk of minor or moderate injury to persons, malfunction, or damage to the product or property when using this product, follow basic precautions, including the following:

INSTALLATION

- Install the product on a firm and level floor.

OPERATION

- Turn off the water faucets and unplug the appliance if the appliance is to be left for an extended period of time, such as during vacations.
- Do not place objects on top of the appliance.
- Do not touch draining water which may be hot.
- If the drain hose and the water supply hose are frozen in winter, defrost before using the appliance.
- ALWAYS follow the fabric care instructions supplied by the garment manufacturer.
- Use fabric softeners or products to eliminate static only as recommended by the manufacturer.
- Do not combine laundry products for use in one load unless specified on the label.
- Do not store or spill liquid detergents, cleaners, or bleaches (chlorine bleach, oxygen bleach) on the appliance. Doing so may result in corrosion, discoloration or damage to the surface of the appliance.

SAVE THESE INSTRUCTIONS

PRODUCT OVERVIEW

Parts

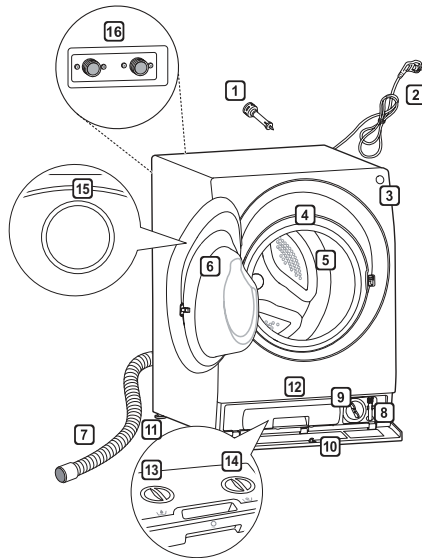

- | | | | |
|-------------------------|---------------------|------------------------------|--|
| 1 Shipping bolts | 5 Tub | 9 Drain pump filter | 13 Liquid detergent dispenser cap |
| 2 Power cord | 6 Door | 10 Lower cover | 14 Liquid softener dispenser cap |
| 3 Power button | 7 Drain hose | 11 Leveling feet | 15 Control panel |
| 4 Drum light | 8 Drain pump | 12 Auto Dispense tray | 16 Water inlets |

Accessories

Included Accessories



Non-skid pads

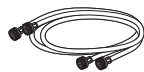

Hot/cold water hoses



Caps for covering shipping bolt holes



Collapsible manual dispenser (1 EA)



Wrench



Tie strap



Elbow bracket (for securing drain hose)

NOTE

- For your safety and for extended product life, use only authorized components. The manufacturer is not responsible for product malfunction or accidents caused by the use of separately purchased unauthorized components or parts.
- The images in this guide may be different from the actual components and accessories, which are subject to change by the manufacturer without prior notice for product improvement purposes.

Installation Parts and Tools

Tools Needed

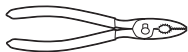

Adjustable Pliers



Carpenter's Level

Installation Overview

Please read the following installation instructions first after purchasing this product or transporting it to another location.

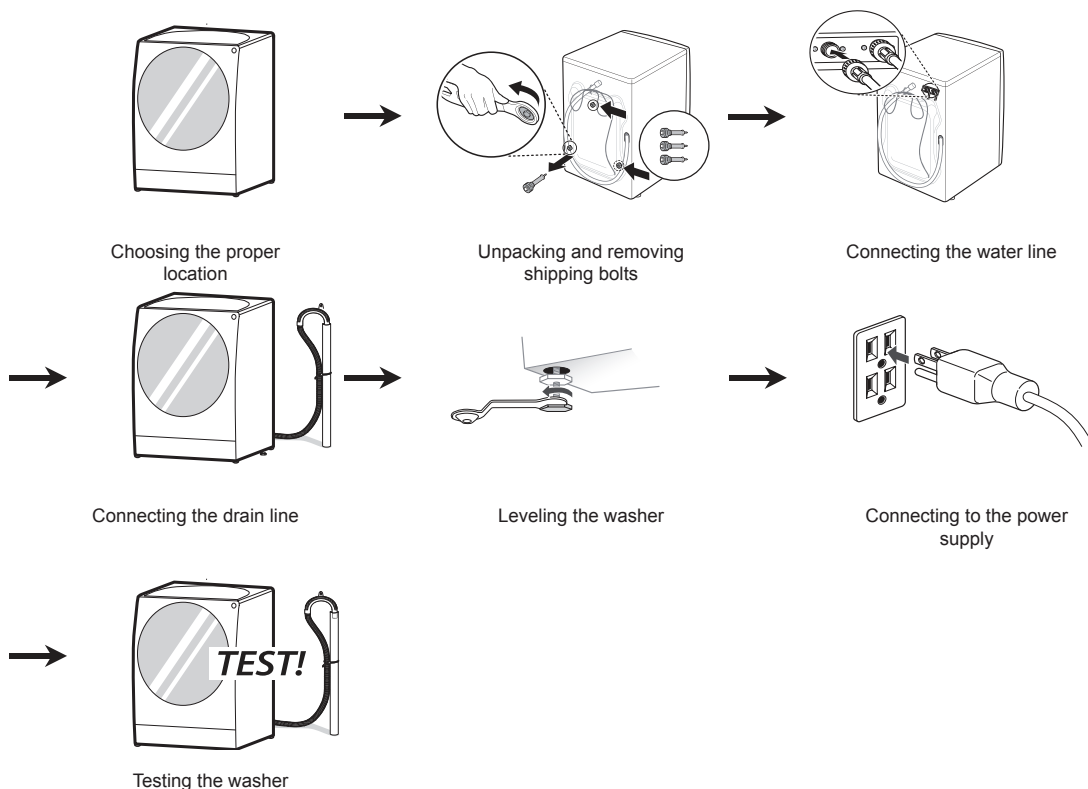

WARNING

- Moving or installation of the appliance requires two or more people. Failure to follow these instructions may result in injury.
- Store and install the appliance where it will not be exposed to temperatures below freezing or exposed to outdoor weather conditions. Failure to follow this warning can cause product or part failure, serious injury, fire, electric shock, or death.
- Properly ground the washer to conform with all governing codes and ordinances. Failure to follow this warning can cause serious injury, fire, electric shock, or death.
- To reduce the risk of electric shock, do not install the appliance in humid spaces. Failure to follow this warning can cause serious injury, fire, electric shock, or death.
- To ensure proper air flow, do not block the large opening on the bottom of the washer with carpeting or other materials.
- Do not remove the ground prong. Do not use an adapter or extension cord. Plug into a grounded 3-prong outlet. Failure to follow this warning can cause serious injury, fire, electric shock, or death.

Product Specifications

The appearance and specifications listed in this manual may vary due to constant product improvements.

Model LUWM101HWA	
Electrical requirements	120 VAC @ 60 Hz
Min. / Max. water pressure	20 – 120 psi (138–827 kPa)
Dimensions	23 5/8 in (W) x 26 1/2 in (D) x 33 1/2 in (H) 60 cm (W) x 67.5 cm (D) x 85 cm (H)
Net weight	208 lb (94.5kg)
Max spin speed	1600 RPM
Operating Temperature Range	41-95 °F (5-35 °C)

Choosing the Proper Location

Install the washer on a solid floor that is strong and rigid enough to support the weight of the washer, even when fully loaded, without flexing or bouncing. If the floor has too much flex, you may need to reinforce it to make it more rigid. If the floor is not solid, it may cause severe vibration and noise.

NOTE

- Before installing the washer, make sure the floor is clean, dry and free of dust, dirt, water and oil so the washer feet cannot slide easily. Leveling feet that can move or slide on the floor can contribute to excess vibration and noise due to poor contact with the floor.
- If a drip pan must be used, take extra care to follow the instructions provided with the drip pan and make sure the leveling feet are adjusted for firm and even contact with the pan. Use of drip pans and failure to properly level the machine may result in increased vibration and noise during operation.
- Allow for sufficient space between the walls and the washer for installation.
- If the appliance is installed in an area where the temperature is above or below the recommended operating temperature range, it may result in longer drying times or poor drying performance.

Power Outlet

- The power outlet must be within 60 inches (1.5 m) of either side of the washer.
- The appliance and outlet must be positioned so that the plug is easily accessible.
- Do not overload the outlet with more than one appliance.
- The outlet must be grounded in accordance with current electrical wiring codes and regulations.
- Use a time-delay fuse or circuit breaker.

NOTE

- It is the personal responsibility and obligation of the product owner to have a proper outlet installed by qualified service personnel.

Flooring

- To minimize noise and vibration, the washer must be installed on a solidly constructed floor.

NOTE

- The washer must be installed on firm flooring to minimize vibration during the spin cycle. Concrete flooring is best, but a wood floor is sufficient, provided it is built to FHA standards.

Floor Installation

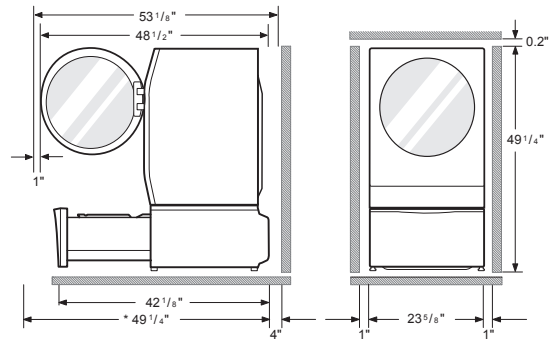

- To minimize noise and vibration, the washer must be installed on a solidly constructed floor.

NOTE

- Refer to the instructions packaged with the optional pedestal kit before installing with a pedestal kit.

Unpacking and Removing Shipping Bolts

1 Lift the washer off the foam base.

After removing the carton and shipping material, lift the washer off the foam base. Make sure the plastic tub support comes off with the base and is not stuck to the bottom of the washer.

If you must lay the washer down to remove the base packaging materials, always protect the side of the washer and lay it carefully on its side. Do not lay the washer on its front or back.

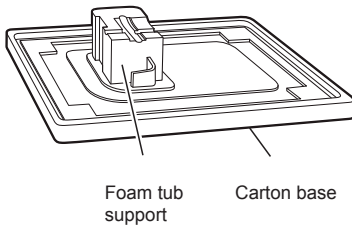

2 Remove the bolt assemblies.

Starting with the bottom two shipping bolts, use the wrench (included) to fully loosen all four shipping bolts by turning them counterclockwise. Remove the bolt assemblies by wiggling them slightly while pulling them out.

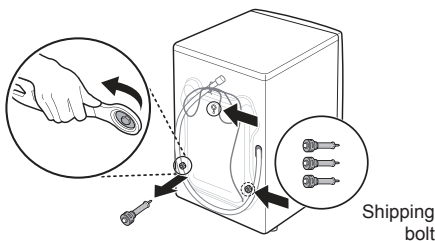

NOTE

- Save the bolt assemblies for future use. To prevent damage to internal components, do not transport the washer without reinstalling the shipping bolts.
- Failure to remove shipping bolts and retainers may cause severe vibration and noise, which can lead to permanent damage to the washer. The cord is secured to the back of the washer with a shipping bolt to help prevent operation with shipping bolts in place.

Connecting the Water Lines

1 Check the fittings and seals.

Inspect the threaded fitting on each hose and make sure there is a rubber seal in place in both ends of each hose to prevent leaking.

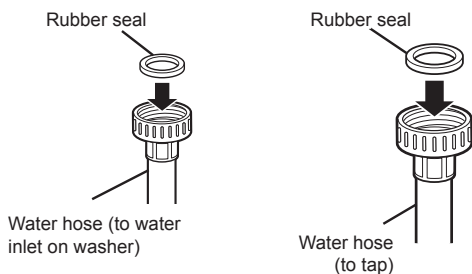

2 Connect the water supply hoses.

Connect the water supply hoses to the hot and cold water faucets tightly by hand and then tighten another 2/3 turn with pliers. Connect the blue hose to a cold water faucet and the red hose to a hot water faucet.

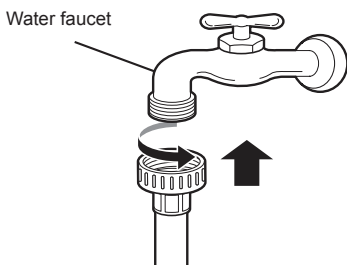

3 Flush out the inlet hoses.

After connecting the inlet hoses to the water faucets, turn on the water faucets to flush out foreign substances (dirt, sand or sawdust) in the water lines. Let water drain into a bucket, and check the water temperature to make sure you've connected the hoses to the correct faucets.

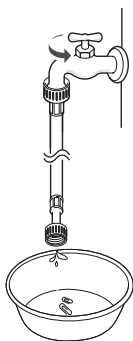

4 Attach the water lines to the back of the washer.

Attach the hot water line to the hot water inlet on the back of the washer. Attach the cold water line to the cold water inlet on the back of the washer. Tighten the fittings securely. Turn ON both faucets all the way and check for leaks at both ends of the hoses.

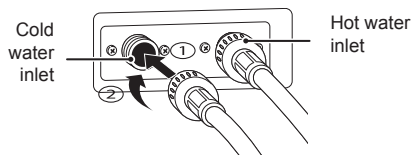

⚠ WARNING

- Do not overtighten the hoses or crossthread the hose fittings. Overtightening or cross-threading can damage the valves, resulting in leaking and property damage.
- Do not overtighten. Damage to the coupling can result.

⚠ CAUTION

- Do not reuse old hoses. Use only new hoses when installing the washer. Old hoses could leak or burst causing flooding and property damage. Contact an LG Customer Information Center for assistance in buying hoses.

NOTE

- Periodically check the hoses for cracks, leaks, and wear, and replace the hoses every five years. Do not stretch the water hoses intentionally, and make sure that they are not pinched, crushed or kinked by other objects.
- Water supply pressure must be between 20 psi and 120 psi (138 – 827 kPa). If the water supply pressure is more than 120 psi, a pressure reducing valve must be installed.
- To provide optimum washing performance, the hot water temperature should be set at 120 – 135 °F (48 – 57 °C) and the cold at 60 °F (15 °C).
- The washer should never be installed or stored in a location subject to freezing temperatures. Damage to the water lines and internal mechanisms of the washer can result. If the washer was exposed to freezing temperatures prior to installation, allow it to stand at room temperature for several hours before use and check for leaks prior to operation.

Connecting the Drain Hose

NOTE

- The drain hose should always be properly secured. Failure to properly secure the drain hose can result in flooding and property damage.
- The drain must be installed in accordance with any applicable local codes and regulations.
- Make sure that the drain hose is not stretched, pinched, crushed, or kinked.
- Do not install the drain hose with the end lower than 29.5 inches (0.7 m) or higher than 96 inches (2.4 m) above the bottom of the washer or more than 60 inches (1.5 m) away from the washer.
- Never create an airtight seal between the hose and the drain with tape or other means. If no air gap is present, water can be siphoned out of the tub resulting in poor wash/rinse performance or clothing damage.

Option 1: Standpipe

1 Clip the end of the hose into the elbow bracket.

Connect the elbow bracket within 4 inches (10 cm) of the end of the drain hose. If the drain hose is extended more than 4 inches (10 cm) beyond the end of the elbow bracket, mold or microorganisms could spread to the inside of the washer.

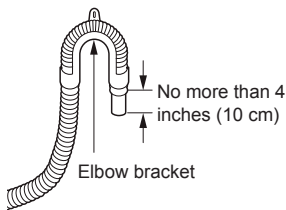

2 Insert the end of the drain hose into the standpipe.

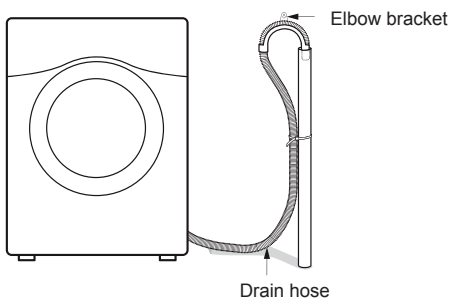

3 Use a tie strap to secure the drain hose in place.

Option 2: Laundry Tub

1 Clip the end of the hose into the elbow bracket.

Connect the elbow bracket within 4 inches (10 cm) of the end of the drain hose. If the drain hose is extended more than 4 inches (10 cm) beyond the end of the elbow bracket, mold or microorganisms could spread to the inside of the washer.

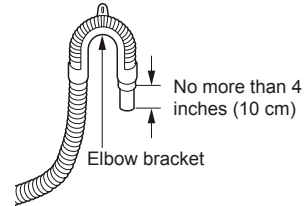

2 Hang the end of the drain hose over the side of the laundry tub.

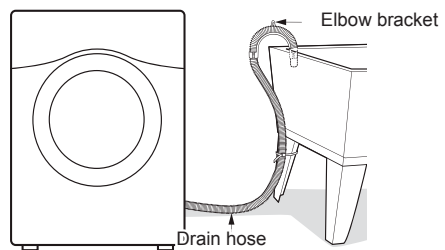

3 Use a tie strap to secure the drain hose in place.

Leveling the Washer

The drum of your new washer spins at very high speeds. To minimize vibration, noise, and unwanted movement, the floor must be a level, solid surface. The slope beneath the washer should not exceed 1 inch, and all four leveling feet must rest firmly on the floor.

NOTE

- Adjust the leveling feet only as far as necessary to level the washer. Extending the leveling feet more than necessary can cause the washer to vibrate
- Before installing the washer, make sure that the floor is clean, dry and free of dust, dirt, water and oil so the washer feet cannot slide easily. Feet that move or slide on the floor can contribute to excessive vibration and noise due to poor contact with the floor.

1 Position the washer in its final location.

Take special care not to pinch, strain, or crush the water and drain lines. If you have a carpenter's level, you can place it across the top of the washer.

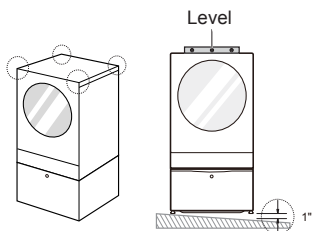

2 Adjust the lower leveling feet.

Turn in one direction to raise the washer or the other direction to lower it.

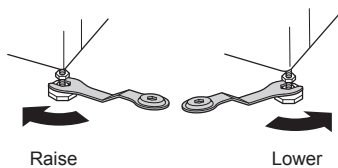

3 Tighten the locknuts.

Turn the locknuts counterclockwise and tighten them when the washer is level.

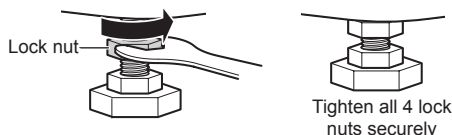

4 Recheck the washer's levelness.

Push or rock the top edges of the washer gently to make sure the washer does not rock. If the washer rocks, repeat steps 1-3.

CAUTION

- Using the washer without leveling it may cause excess vibration and noise, leading to a machine malfunction.
- Extend the leveling feet only to level the washer. If you extend the leveling feet unnecessarily, it may cause abnormal vibration of the washer.

Using Non-Skid Pads

If you install the washer on a slippery surface, it may move because of excessive vibration. Incorrect leveling may cause malfunction through noise and vibration. If this occurs, install the non-skid pads under the leveling feet and adjust the level.

1 Clean the floor to attach the non-skid pads.

Use a dry rag to remove and clean foreign objects or moisture. If moisture remains, the non-skid pads may slip.

2 Adjust the level after placing the washer in the installation area.

3 Place the adhesive side of the non-skid pad on the floor.

It is most effective to install the non-skid pads under the front legs. If it is hard to place the pads under the front legs, place them under the back legs.

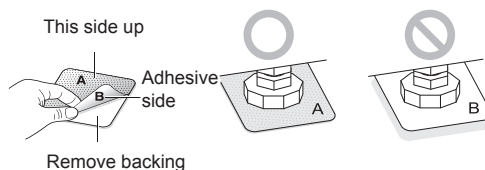

4 Recheck the washer's levelness.

Push or rock the top edges of the washer gently to make sure that the washer does not rock. If the washer rocks, level the washer again.

Connecting to the Power Supply

The washer should be plugged into a 120 VAC, 60 Hz grounded 3-prong outlet. Plug in the washer.

WARNING

- Do not use a worn or damaged power cord or power plug. Replace or repair it immediately. Failure to do so may result in death, fire, electric shock, or malfunction.
- Do not modify the power cord and plug provided with the appliance. Take care not to damage it when installing or moving the washer. Failure to do so may result in death, fire, electric shock, or malfunction.
- Make sure that the washer is grounded.
- Connect this washer to a grounded outlet conforming to the rating prior to use. Failure to do so may result in fire, electric shock, or malfunction.
- Do not damage or cut off the ground prong of the power cord. Doing so may cause death, fire, electric shock, or product malfunction.
- Improper connection of the equipment-grounding conductor can result in risk of electric shock. Check with a qualified electrician or service technician if you are in doubt as to whether the appliance is properly grounded. If it does not fit the outlet, have a proper outlet installed by a qualified electrician
- The appliance and outlet must be positioned so that the plug is easily accessible.
- Do not use adapters or extension cords. Doing so may result in serious injury, fire, electric shock, or death.
- For best performance, plug the washer into its own individual outlet. This helps prevent overloading house wiring circuits which could cause a fire hazard from overheated wires.
- If necessary, use a new, UL-listed 3-prong adapter or 3-wire extension cord with a 3-prong (grounding) plug rated at no less than the branch circuit. Do not use an extension cord longer than 3 feet. Failure to follow these warnings may result in serious injury, fire, electric shock, or death.

Testing the Washer

Check if the washer is properly installed and run a test cycle.

- 1** Load the washer with 6 pounds of laundry (approximately 6 thick bath towels).
- 2** Press the **Power** button.
- 3** Press the **Rinse+Spin** cycle.
- 4** Press the **Start/Pause** button.
The wash cycle starts.
- 5** Check if water is supplied, that the machine does not rock or vibrate excessively, and that it drains well during the spin cycle.

NOTE

- If water leaks during water supply, see Connect the Water Lines to connect them properly.
- If the washer rocks and vibrates excessively, see Level the Washer to level it again.
- If the drain does not work, see Connect the Drain Hose to install the hose properly.

OPERATION

Using the Washer

WARNING

- To reduce the risk of fire, electric shock, or injury to persons, read the SAFETY INSTRUCTIONS before operating this appliance.

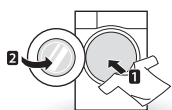

1 Sort Laundry and Load the Washer

Sort laundry by fabric type, soil level, color and load size, as needed. Open the door and load items into the washer.



2 Cleaning Products

Add the proper amount of HE (High-Efficiency) detergent and liquid fabric softener to the Auto Dispense reservoir or the manual dispenser. If desired, use the manual dispenser to add powdered oxygen-based bleach. Do not use liquid chlorine bleach.



3 Turn on the Washer

Press the **Power** button to turn on the washer. After a short delay, the display will illuminate and a chime will sound.

4 Cycle Buttons

Touch a cycle icon in the display to select a cycle. Swipe left in the display to see additional cycles.



5 Adjust Settings

Default settings for the selected cycle can now be changed, if desired, by selecting the options in the display. See the Control Panel section for more details.

NOTE

- Not all modifiers and options are available on all cycles. The selection will not appear in the display if it is not allowed.



6 Begin Cycle

Press the **Start/Pause** button to begin the cycle. The washer will agitate briefly without water to measure the weight of the load. If the **Start/Pause** button is not pressed within 15 minutes, the washer will shut off and all settings will be lost.

7 End of Cycle

When the cycle is finished, a melody will sound. Immediately remove your clothing from the washer to reduce wrinkling. Check around the door seal when removing the load for small items that may be caught in the seal.

NOTE

- The washer rotates the laundry in a way that allows it to use less water while still fully saturating your clothing. It is normal to not be able to see water during the wash cycle. If the temperature or the water level inside the machine is too high, the door locks and cannot be opened. To open the door while washing, use the Rinse+Spin cycle.

Sorting Laundry

CAUTION

- The washer can be fully loaded, but the drum should not be tightly packed with items. The door of the washer should close easily.
- Use the Bulky/Large cycle for buoyant or nonabsorbent items such as pillows or comforters. Failure to follow this caution can result in leakage.
- If possible, do not wash any water-resistant items. If you must, please select the Bulky/Large cycle.

Grouping Similar Items

For the best washing results, and to reduce the possibility of damage to clothing, care should be taken to sort the clothing into loads that are made up of similar items.

Mixing different fabric types and/or soil levels can result in poor wash performance, color transfer, discoloration, fabric damage or linting. Fabrics should be sorted into groups as described below.

Colors

Sort articles by color. Wash dark clothes together in a separate load from light colors or whites. Mixing dark clothes with light clothes can result in dye transfer or discoloration of the lighter clothes.

Soil Level

Wash heavily soiled clothing together. Washing lightly soiled clothing in the same load with heavily soiled clothing could result in poor wash performance for the lightly soiled clothing.

Fabric Type

Delicate articles should not be mixed with heavy or sturdy fabric types. Washing heavy fabrics in a delicate load can result in poor wash performance for the heavy fabrics and possible damage to the delicates.

Lint Type









Some fabrics attract and bind lint to them while others give off lint in the laundry process. Avoid mixing these lint collectors and lint producers in the same load. Mixing these fabrics will result in pilling and linting on the lint collectors. (For example, lint collector—knit sweater; lint producer—terry cloth towels.)

Sort Laundry

By colors	By Soil	By Fabric	By Lint
White	Heavy	Delicates	Lint Producer
Lights	Normal	Easy Care	Lint Collector
Darks	Light	Sturdy	

Fabric Care Labels

Many articles of clothing include a fabric care label. Using the chart below, adjust the cycle and option selections to care for your clothing according to the manufacturer's recommendations.

Category	Label	Directions
Washing		Hand wash
		Machine wash, Normal cycle
		Perm Press/Wrinkle Resistant setting (which has a cool down or cold spray before the slower spin)
		Gentle/Delicate setting (slow agitation and/or reduced wash time)
		Do not wash
		Do not wring
Water Temperature	...	Hot
	..	Warm
	.	Cold/Cool
Bleach Symbols		Any bleach (when needed)
		Only non-chlorine bleach (when needed)
		Do not bleach

Loading the Washer

- Check and empty pockets. Paper clips, coins, matches, etc. can damage clothing and the washer.
- Close zippers and hooks, and tie drawstrings to prevent snagging or tangling of clothes.
- Pretreat heavily stained areas for best results.
- Combine large and small items in a load. Load large items first. Large items should not be more than half of total load.
- The washer can be fully loaded, but the drum should not be tightly packed with items. The door of the washer must close easily.
- Do not wash single small items. Add 1-2 similar items to the load to prevent an out-of-balance load.
- Wash thick, bulky items individually. Heavy blankets, comforters, bedspreads, or pet beds can get tangled or cause an unbalanced load if combined with other items.
- Do not wash/spin waterproof items. Washing raincoats or sleeping bags may result in abnormal vibration or may cause the load to bounce, which could damage the drum.
- Wash small, light items in a mesh bag. Items like underwear can get caught in the door seal, and a brassiere hook may damage other items or the drum.
- Brush off heavy soil, dust, and hair from items before washing. Excess dirt or sand can abrade other fabrics and lead to poor wash performance.
- For best performance, load clothes as shown.

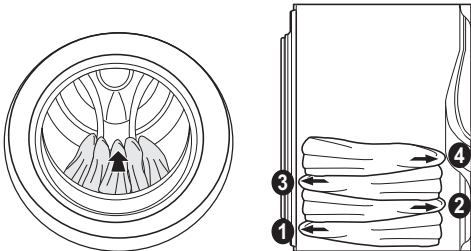

- Load clothes loosely, and do not overfill the drum. Clothes need room to circulate in order to get clean.
- Do not press down on items while stacking them in the drum.

Adding Cleaning Products

Using the Auto Dispense Function

When the Auto Detergent and Auto Softener functions are turned on, detergent and softener are automatically dispensed in amounts based on the load size, at the appropriate time during the cycle.

- 1 Press the O mark to open the lower cover as shown below.**

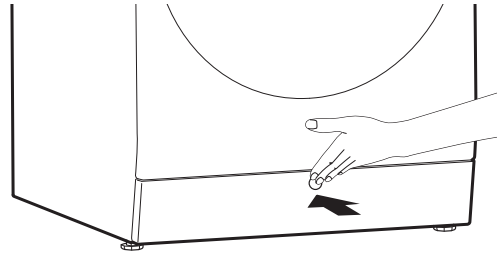

- 2 Press PUSH on the Auto Dispense tray as shown. Use the handle to pull the tray out.**

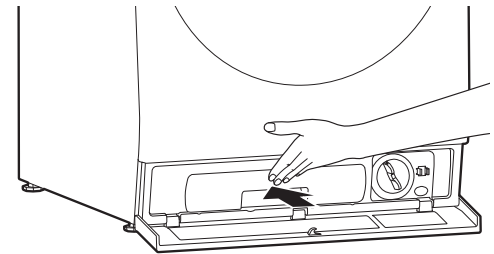

- 3 Turn the caps on the Auto Dispense tray to the left to open the two reservoirs.**

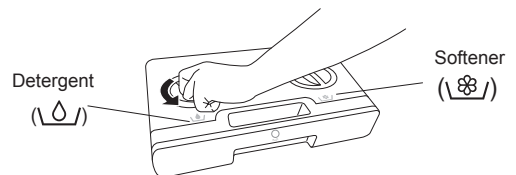

4 Pour the detergent and softener into their respective reservoirs.

- The Auto Dispense tray has two reservoirs. Put the liquid detergent (🧴) into the left reservoir and the fabric softener (🧺) into the right reservoir.
- Fill to the Max line.

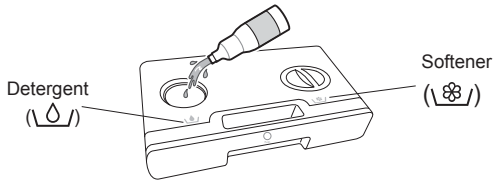

5 After filling, insert and turn the caps to the right until tightly closed.

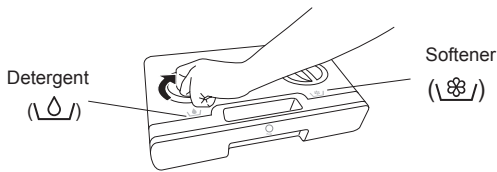

6 Insert the Auto Dispense tray until it clicks.

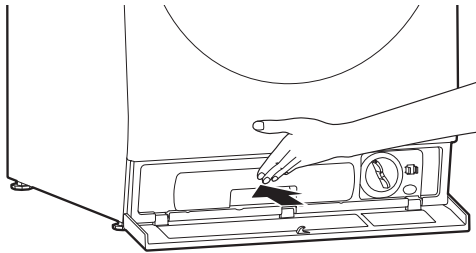

7 Close the lower cover.

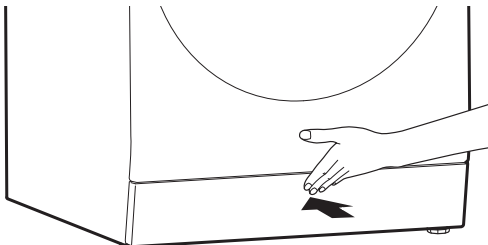

8 Touch the icon at the top of the display to open the Settings screen and select the Auto Detergent and Auto Softener functions.

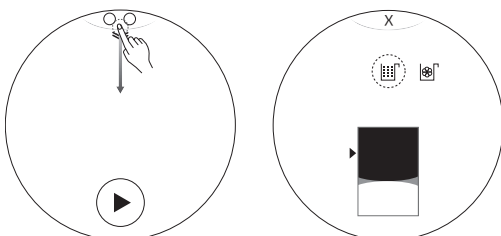

NOTE

- Before using the appliance, make sure there is detergent in the Auto Dispense reservoir.
- A full detergent reservoir will last for about 18 standard cycles, with half a load of laundry in the drum.
- The default settings are configured to automatically dispense 2.4 oz (70 ml) of detergent and 1 oz (30 ml) of softener for 8-12 lb (4-6 kg) of normally soiled laundry. This can be changed using the **More Settings** button. For more details, see the Settings section of this manual.
- To set the Auto Dispense amounts for 8-12 lb (4-6 kg), see the manufacturer's recommendations on the detergent or fabric softener.
- When you select **Auto Wash**, **Auto Detergent** is automatically turned on.
- Turn on the detergent/softener refill alarm to be notified of when the reservoirs need to be refilled.
- Remove any residual detergent on the outside of the Auto Dispense tray before inserting it.
- To change detergents, follow the steps above or turn off the Auto Detergent function and use the included manual dispenser.
- Do not use force when pulling out the Auto Dispense tray.
- To use the Auto Detergent function with the Wool cycle or other cycles where a neutral detergent is recommended, touch Cancel when prompted.
- Always use HE (High-Efficiency) detergent with this washer.

⚠ WARNING

- Do NOT mix chlorine bleach with ammonia or acids such as vinegar or rust/scale remover. Mixing chemicals like these can produce a lethal gas, resulting in severe injury or death.

⚠ CAUTION

- Do not place or store laundry products, such as detergent, bleach, or liquid fabric softener, on top of the washer or dryer. Wipe up any spills immediately. These products can damage the machine's finish and controls.
- Remove the Auto Dispense tray only when refilling or replacing detergent or softener.
- Use only liquid HE detergents in the Auto Dispense tray.
- Do not pour any powdered cleaning products into the Auto Dispense reservoirs.
- Do not put liquid bleach into the Auto Dispense tray or the manual dispenser.
- The Auto Dispense function may not work properly with some concentrated gel detergents. Use the manual dispenser to dispense gel detergents.
- Do not mix detergent with fabric softener.
- Use care when removing and inserting the Auto Dispense tray, as detergent or fabric softener may spill. Wipe up any spills before proceeding.
- To use the Auto Dispense function, Auto Detergent and/or Auto Softener must be turned on in the Settings screen.
- Detergent or fabric softener left in the Auto Dispense reservoirs for an extended period may harden and fail to dispense properly.
- The ventilation holes help in dispensing the detergent and fabric softener. Do not hold the Auto Dispense tray upside down, as cleaning products may leak.

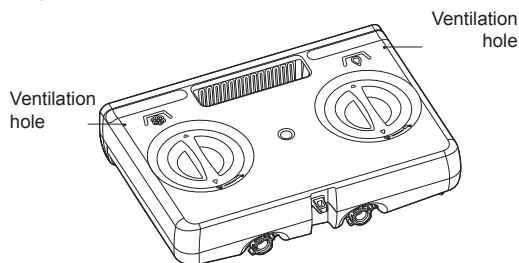

- Do not block the ventilation holes in the Auto Dispense tray.

Dispensing Detergent Manually

To manually dispense powdered detergent or neutral detergent, disable the Auto Detergent function and use the provided manual dispenser. To dispense oxygen-based bleach, leave the Auto Detergent function on. Do not use the manual dispenser with liquid bleach.

- 1 **Turn off Auto Detergent function, if necessary.**
- 2 **Measure and pour cleaning product into manual dispenser.**



Place manual dispenser on top of clothing in drum.



NOTE

- Dispense the detergent by referring to the scale mark in the manual dispenser.
- When washing is finished, wash the manual dispenser clean before storing it.
- To use fabric softener, turn on the **Auto Softener** function.
- Do not use the manual dispenser with the **Auto Detergent** function turned on. Excessive suds will remain even after rinsing, causing a longer rinsing time or preventing a proper rinsing.
- When you use the Delay Wash function, Auto Dispense is recommended.
- Manual dispenser can be collapsed for easy storage.



⚠ CAUTION

- Dispense the fabric softener using the Auto Detergent function.
- Carefully place the manual dispenser on top of clothes, to avoid spilling detergent directly onto clothing. Detergents with strong bleaching properties could cause damage to clothing.

Control Panel

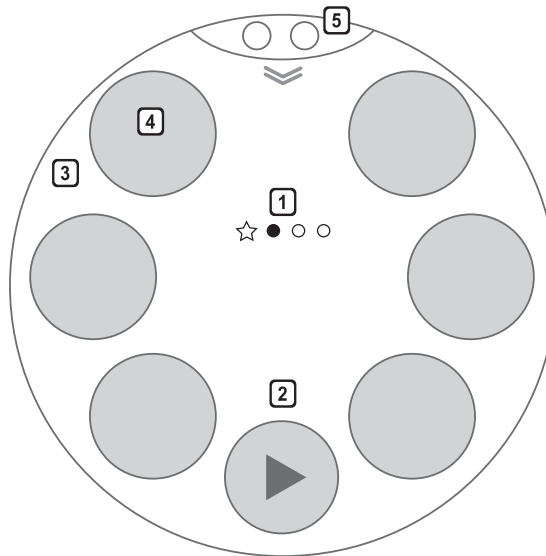

Control Panel Features

1 Cycle Category

The dots indicate the current category screen. Swipe the display left or right to show Everyday Cycles, Special Cycles, Dry Cycles(Optional), Download Cycles, and My Pattern.

Use My Pattern for cycles you use frequently. If you run the same cycle more than three times, it will be registered under **My Pattern**.

Cycle categories may differ on some models.

2 Start/Pause Button

Press this button to start the selected cycle. If the washer is running, use this button to pause the cycle without losing the current settings.

NOTE

- If Start/Pause is not pressed within 15 minutes of selecting a cycle, the washer automatically turns off and all cycle settings are lost.

3 Time and Status Display

The display shows the settings, estimated time remaining, options, and status messages for your washer. When the washer is turned on, the default settings in the display will illuminate.

4 Cycles

You may select a desired cycle. For more information, see the Wash Cycles section.

Download new and specialized cycles that are not included in the appliance's standard cycles in the **Download Cycles** category.

5 Quick Setting

Control Lock, Remote Start, Auto Detergent, Auto Softener, Selection of Main Washer and Mini Washer, and More Settings are displayed. Touch a function to turn it on or off.

Wash Cycles

Wash cycles are designed for the best wash performance for each type of load. Select the cycle that best matches the load contents for maximum wash performance and fabric care. For best results, follow the fabric care labels on your garments. See the Sorting Laundry section for a guide to the symbols used on fabric care labels.

Swipe through the cycle category screens and touch a cycle icon to select the desired cycle. When you select a wash cycle, the icon for the cycle will be highlighted in the screen.

NOTE

- Whenever load weights are mentioned, assume 1 lb (0.45 kg) = 1 thick bath towel (dry).
- For information on using SmartThinQ™ applications to save energy, see the Smart Functions section.

Choosing by	Wash Cycle	Description
Fabric Type	Normal	Use this cycle to wash all normal items, except delicate fabrics such as wool or silk. NOTE: Pressing the Start/Pause button without selecting a cycle will cause the Normal cycle to begin immediately, using the default settings.
	Wool	This cycle is for washing 100% pure wool items only. (Use detergent for machine-washable woolens.)
	Delicate	This cycle is for washing lingerie or sheer and lacy clothes which can easily be damaged.
	Perm.Press	Use this cycle to wash wrinkle-free clothes or tablecloths, to minimize wrinkles.
	Gentle Care	Use this cycle for hand-washable clothes such as lingerie, dresses etc.
	Outdoor	Use this cycle for garments that are specially designed and treated for outdoor use.
Load Size	Normal	If you have a mixed load that is half-size, use the Normal cycle with default settings. For full-size loads, use the Normal cycle with the soil level set to heavy, and add an extra rinse. In both cases, the machine will automatically detect the load size and adjust accordingly.
	Speed Wash	Use the Speed Wash cycle to quickly wash lightly soiled clothing and small loads. For high wash and rinse efficiency, wash small loads of 2-3 lightly-soiled garments (less than 3 lb. (1.36 kg)). NOTE: Use very little detergent in this cycle. For additional rinsing, add an extra rinse in the Rinse option screen.
	Bulky/Large	This cycle is for washing king or queen sized comforters. NOTE: Using the Bulky/Large cycle with a low spin speed is recommended when washing waterproof or water-resistant items, to help protect the fabrics' properties. If your washer does not function properly, manually redistribute the load or put one comforter in at a time.
	Auto Wash	Use this cycle to adjust wash and rinse patterns automatically after detecting load size and soil level.

Choosing by	Wash Cycle	Description
Convenience	Speed Wash	Use the Speed Wash cycle to quickly wash lightly soiled clothing and small loads. For high wash and rinse efficiency, wash small loads of 2-3 lightly-soiled garments (less than 3 lb. (1.36 kg)). NOTE: Use very little detergent in this cycle. For additional rinsing, add an extra rinse in the Rinse option screen.
	Rinse+Spin	Select this option to rinse and spin a load separately from a regular cycle. This can be helpful in preventing fresh stains from setting in fabrics. Change the spin speed in the Spin options screen after selecting the cycle.
	Tub Clean	Use this cycle to clean the washer's drum. See Tub Clean Cycle in the Maintenance section.
	Speed Wash+Dry	This cycle provides both washing and drying within 80 minutes for up to 3 lightly soiled shirts.
Soil Level	Normal	For tough stains on children's clothes, use the Normal cycle with a hot Wash Temp. setting, plus the Prewash option and an Extra Rinse.
	Heavy Duty	This cycle is for washing heavily soiled laundry using more powerful wash motions.
	Allergiene™	This cycle is a powerful, high-temperature cycle designed specifically to reduce certain allergens. NOTE <ul style="list-style-type: none"> • Selecting the Allergiene™ cycle automatically incorporates steam into the wash cycle. • The Allergiene™ cycle can significantly reduce allergens in bedding and clothing. • The Allergiene™ cycle helps reduce dust mite populations and helps reduce allergens. Due to the higher energy and temperatures used, the Allergiene™ cycle is not recommended for wool, silk, leather, or any other delicate or temperature sensitive items.
	Sanitary	This cycle reduces 99.9% of bacteria on laundry when used in conjunction with bleach, without high energy consumption.

Cycle Guide

● = available option, ■ = default setting

Cycle	Cycle Options	Wash Temp	Spin Speed	Soil Level	Delay Wash	Extra Rinse
Normal	Turbo Wash	Extra Hot	Extra High	Heavy	●	●
	Prewash	Hot	Very High			
		Warm	High	Normal		
	Fresh Care	Cold	Medium			
		Tap Cold	Low	Light		
			Very Low			
Speed Wash		Hot			●	●
		Warm				
	Fresh Care	Cold	Medium			
			Low	Light		
			Very Low			
Heavy Duty		Extra Hot	Extra High	Heavy	●	●
	Prewash	Hot	Very High			
	Hygienic Rinse	Warm	High			
	Fresh Care	Cold	Medium			
		Tap Cold	Low			
			Very Low			
Auto Wash		Hot	Very High		●	
			High	Normal		
	Fresh Care		Medium			
			Low			
			Very Low			
Perm.Press	Turbo Wash	Extra Hot		Heavy	●	●
	Prewash	Hot	Very High			
	Hygienic Rinse	Warm	High	Normal		
	Fresh Care	Cold	Medium			
		Tap Cold	Low	Light		
			Very Low			
Wool		Hot		Heavy	●	●
		Warm		Normal		
	Fresh Care	Cold	Medium			
		Tap Cold	Low	Light		
			Very Low			

● = available option, ■ = default setting

Cycle	Cycle Options	Wash Temp	Spin Speed	Soil Level	Delay Wash	Extra Rinse
Allergiene™		Extra Hot	Extra High	Heavy	●	●
			Very High			
	Hygienic Rinse		High	Normal		
	Fresh Care		Medium			
			Low			
			Very Low			
Sanitary		Extra Hot		Heavy	●	●
	Hygienic Rinse		High	Normal		
	Fresh Care		Medium			
			Low			
Speed Wash+Dry	Turbo Wash				●	●
		Hot	Very High			
		Warm				
		Cold				
				Light		
Baby Wear		Extra Hot		Heavy	●	●
	Prewash	Hot				
	Hygienic Rinse	Warm	High	Normal		
	Fresh Care	Cold	Medium			
		Tap Cold	Low			
			Very Low			
Outdoor	Turbo Wash			Heavy	●	●
		Hot				
		Warm		Normal		
	Fresh Care	Cold	Medium			
		Tap Cold	Low	Light		
			Very Low			
Delicate	Turbo Wash			Heavy	●	●
		Hot				
		Warm		Normal		
	Fresh Care	Cold	Medium			
		Tap Cold	Low	Light		
			Very Low			

● = available option, ■ = default setting

Cycle	Cycle Options	Wash Temp	Spin Speed	Soil Level	Delay Wash	Extra Rinse
Tub Clean		Extra Hot				
				Normal		
Rinse + Spin			Extra High			
			Very High			
	Hygienic Rinse		High	Normal	●	●
	Fresh Care		Medium			
			Low			
Spin			Very Low			
			Extra High			
			Very High			
			High			
	Fresh Care		Medium		●	
Bulky/Large			Low			
			Very Low			
	Turbo Wash			Heavy		
		Hot				
		Warm		Normal	●	●
	Fresh Care	Cold				
Cotton+		Tap Cold	Low	Light		
			Very Low			
	Turbo Wash	Extra Hot	Extra High	Heavy		
	Prewash	Hot	Very High			
	Hygienic Rinse	Warm	High	Normal	●	●
	Fresh Care	Cold	Medium			
	Tap Cold	Low	Light			
		Very Low				

Cycle Modifier Buttons

Each cycle has default settings that are selected automatically. Customize these settings using the cycle modifier buttons. Press the button for the desired modifier to open the modifier's screen. The washer automatically adjusts the water level for the type and size of wash load for best results and maximum efficiency. Due to the high-efficiency nature of this product, water levels may be much lower than expected. This is normal and cleaning/rinsing performance will not be compromised.

When you select a cycle, washing starts with the default settings. If needed, modify the cycle as shown below.

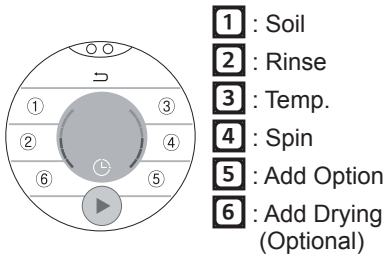

- 1** Press the **Power** button.
- 2** Select a washing cycle.
- 3** Select the options you want to change.
- 4** Change the options and press the **OK** button.
- 5** Press the **Start/Pause** button.

1 Soil

Adjusting the soil level setting will change the cycle times and/or wash actions. Touch the Soil button to open the modifier's screen and change the default soil level.

NOTE

- This feature needs more time for heavily soiled loads or less time for lightly soiled loads.

2 Rinse

This option adds an extra rinse to the selected cycle to help ensure the removal of detergent or bleach residue from fabrics. Liquid fabric softener, if used, is always dispensed in the final rinse. Touch the Rinse button to open the modifier's screen and add rinses to the cycle.

3 Temp.

Temp. selects the wash and rinse temperature combination for the selected cycle. Touch the Temp button to open the modifier's screen and change the default temperature setting. Cold rinses use less energy. The actual cold rinse temperature depends on the temperature of the cold water at the faucet.

The washer features a heating element to boost the hot water temperature for Extra Hot settings. This provides improved wash performance at normal water heater settings.

NOTE

- Select the water temperature suitable for the type of load you are washing. Follow the garment fabric care labels for best results.

4 Spin

Higher spin speeds extract more water from clothes, reducing drying time and saving energy. Touch the Spin button to open the modifier's screen and change the default spin speed. Some fabrics, such as delicates, require a slower spin speed. To protect your clothing, not all spin speeds are available for all cycles.

- The Rinse+Spin and Spin cycles are available in the last cycle category screen.

5 Add Option

Option settings may be different depending on the cycle.

Turbo Wash

Adding the Turbo Wash™ option reduces the cycle time while still providing similar wash performance to the same cycle without Turbo Wash™.

NOTE

- The Turbo Wash™ option cannot be used with all cycles.
- Turbo Wash™ defaults to on for Normal, Heavy Duty and Perm.Press wash cycles.

Prewash

Add the Prewash option to heavily soiled loads.

NOTE

- If you select Prewash after putting the detergent directly in drum, the detergent may be washed away, reducing the washing performance. For best results, use **Prewash** with the Auto Detergent function.

Hygienic Rinse

Use this option to improve cleaning or rinsing performance. The final rinse is heated to 104°F (40°C).

Fresh Care

Use this function when you won't be able to take out your clothes immediately after the wash cycle ends. After the cycle ends, the drum will tumble periodically for up to 19 hours to prevent wrinkles. Press the **Start/Pause** or **Power** button at any time to unload laundry.

NOTE

- To prevent tangling of your laundry, the tub will rotate for a certain period of time after spinning is finished.

6 Add Drying

Option settings may vary based on the dry cycle selected. Refer to the Drying Cycle Guide.

Air Cooling

Use this setting for air drying temperature sensitive items or to cool down clothes after drying, if they are too hot to handle.

Normal

Use the Normal Dry setting to dry normal fabrics.

Damp

Use Damp Dry to leave clothes slightly damp for easier ironing.

Energy Saving

Use this special setting to optimize energy consumption during drying.

Speed

Use Speed Dry to dry clothes more quickly.

Time Drying (30/60/90/120 min)

Time Dry allows you to manually set the dry time, from 30 to 120 minutes, in 30-minute increments.

Drying Cycle Guide

● = available option, ■ = default setting

Cycle	Cycle Options	Wash Temp	Spin Speed	Soil Level	Delay Wash	Extra Rinse
Normal	Air Cooling		Extra High		●	
	Normal		Very High			
	Damp		High			
	Energy saving					
	Speed					
	Time Drying (30/60/90/120 min)					
Outdoor	Air Cooling				●	
	Normal					
	Damp		High			
			Medium			
Time Dry	Air Cooling		Extra High		●	
			Very High			
			High			
	Time Drying (30/60/90/120 min)					
Wash+Dry	Air Cooling	Extra Hot	Extra High	Heavy	●	●
	Normal	Hot	Very High			
	Damp	Warm	High	Normal		
	Energy saving	Cold				
	Speed	Tap Cold		Light		
	Time Drying (30/60/90/120 min)					
Perm. Press	Air Cooling				●	
	Normal		Very High			
	Damp		High			
			Medium			
Delicate	Air Cooling				●	
	Normal					
			Medium			

Special Cycles/Features

After selecting a cycle, press the buttons to select additional features for your load.

Delay Wash

Once you have selected the cycle and other settings, press this button to delay the start of the wash cycle. Each press of the button increases the delay time by 1 hour, for up to 19 hours. Once the desired delay time is set, press the **Start/Pause** button to start the delay time.

Add Garments

Use this function to add garments or remove foreign objects like coins or keys after the cycle has started.

- 1 Press the **Start/Pause** button.
- 2 Press **Add Garments**. The cycle pauses and the door unlocks.
- 3 Open the door, add garments or remove foreign objects, and close the door.
- 4 Press the **Start/Pause** button again to continue the cycle. The cycle continues automatically.

NOTE

- After checking the water level/temperature conditions for safety, the door unlocks once the wash movement has stopped.
- This may take several seconds depending on the water level. When a lot of water is in the tub, the door unlocks after water drains to a safe level.
- If the temperature in the tub is higher than 113 °F (45 °C), a short warning chime sounds and Add Garments is not allowed for safety.
- Add Garments is disabled during the Tub Clean cycle or while a cycle is in Spin mode for safety.
- To preserve wash performance, wash time may be extended depending on when garments are added to a cycle.

WARNING

- Be careful when opening the door as wet laundry may drip or fall out when the door is opened.
- Do not attempt to force the door to open when locked. Doing so could result in damage to the machine, malfunction, or personal injury.

Drying Tips

Use the sensor dry cycles to dry most loads. Electronic sensors measure the temperature of the exhaust to increase or decrease drying temperatures for faster reaction time and tighter temperature control.

- Cold water tap must be left on during drying cycles.
- This washing machine's automatic process from washing to drying can be selected easily.
- For most even drying, make sure all articles in the load are similar in material and thickness.
- Do not overload the washing machine by stuffing too many articles into the drum. Items must be able to tumble freely.
- Remember to press Start/Pause to resume the cycle if you open the door to remove clothing before the cycle is finished.
- When "Cool Down" appears in the display, the dry cycle has finished and the dryer is air drying to reduce wrinkles. Press Start/Pause or the Power button at any time to remove clothing. If not stopped, the cool down will end after about 4 hours.

NOTE

- To spin clothes while drying, select the spin speed in the modifier screen for each dry cycle.
- Be careful when removing your clothing from the washing machine, as the clothing or washing machine may be hot.

Woolen Articles

- Do not tumble dry woolen articles. Pull them to their original shape and dry them flat.

Woven and Loopknit Materials

- Some woven and loopknit materials may shrink, by varying amounts, depending on their quality.
- Always stretch these materials out immediately after drying.

Permanent Press and Synthetics

- Do not overload the washing machine.
- Take out permanent press articles as soon as the washing machine stops to reduce wrinkles.

Baby Clothes and Night Gowns

- Always check the manufacturer's instructions.

Rubber and Plastics

- Do not dry any items made from or containing
 - aprons, bibs, chair covers
 - curtains and table cloths
 - bathmats

Fiberglass

- Do not dry fiberglass articles in the washing machine. Glass particles left in the washing machine may be picked up by your clothes the next time you use the washing machine and cause skin irritation.

Drying Time Guide

- Drying cycles can last up to about 7 hours.
- These drying times are given as a guide to help you set your washing machine for manual drying.
- If the load is not dry after the estimated time, the drying time is modified automatically and the new estimated time appears in the display.

NOTE

- The actual drying time may vary from the estimated drying time for the sensor dry cycles. Drying time is affected by the type of fabric, load size, and selected dry level.

Settings

Swipe down the display to open the Settings screen. Touch More Settings to reveal the entire Settings menu.

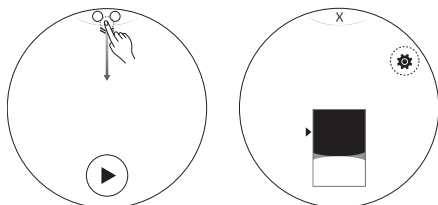

Control Lock

This option disables the controls and can prevent children from changing cycles or operating the machine. The feature does not lock the door. Once the Control Lock is set, it must be deactivated before any controls, except the Power button and Switching between Main Washer and Mini Washer, can be used. Once the washer has shut off, the Power button will allow the machine to be turned on, but the controls will still be locked.

Locking the Control Panel

Press Control Lock in the Settings screen to turn Control Lock on or off.

NOTE

- Turning off the power will not reset the Control Lock function. You must deactivate Control Lock before you can access any other functions.
- When Control Lock is turned on, the Wi-Fi icon on the display window is changed to the Control Lock icon.
- When Control Lock is turned on, you cannot operate any buttons except the Power button, the Settings drop down button, and the button to switch between the Main Washer and Mini Washer.

Unlocking the Control Panel

Press Control Lock in the Settings screen to turn Control Lock on or off.

Wi-Fi

Setup the Wi-fi connection. When Wi-Fi is turned on, the Wi-Fi icon appears in the display.

Remote Start

Use a smart phone to control the appliance remotely or check to see how much time is left in the cycle.

NOTE

- You must first connect to a gateway and register the appliance in order to use the Remote Start function. See the Smart Functions section for more details.

Using Remote Start

- 1 Press the **Power** button.
- 2 Load the laundry.
- 3 Swipe down from the top of the display to open the Settings screen and press **More Settings**. Press **Remote Start** in the Settings menu.

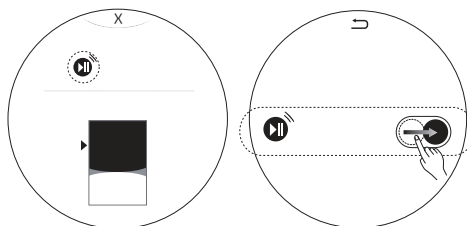

- 4 Start a cycle from the LG Smart ThinQ application on your smart phone.

NOTE

- Once the Remote Start mode is enabled, you can start a cycle from the LG Smart ThinQ smartphone application. If the cycle is not started, the machine will wait to start the cycle until it is turned off remotely from the application or the Remote Start mode is disabled.
- When Remote Start is turned on, the door is automatically locked.

Disabling Remote Start

To disable Remote Start, turn it off in the Settings screen.

NOTE

- Remote Start will not start if the door is open.

Auto Dispense

Use this button to setup and control the Auto Dispense function.

- When the Refill Alarm is turned on, it sends a message when the detergent or softener need refilling.
- The default settings are configured to automatically dispense 2.4 oz (70 ml) of detergent and 1 oz (30 ml) of softener for 8-12 lb (4 - 6 kg) of normally soiled laundry.

Changing Default Dispense Amounts

- 1 Press the **Power** button.
- 2 Swipe the display down to see the Settings screen and select **More Settings**. Select **Auto Dispense** from the Settings menu.

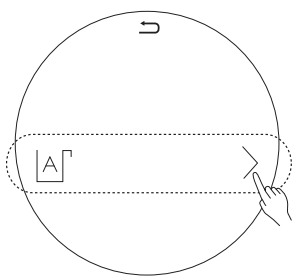

- 3 Turn on **Auto Detergent**.

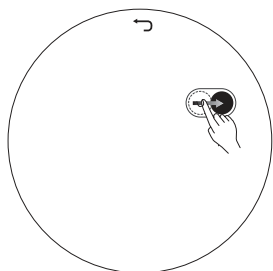

- 4 Change the default Auto Dispense amount as desired and press **OK**.

Sound

Use this option to turn on or off the sound when a button is pressed.

Brightness

Set brightness from 20% to 100%.

Language

Change the display language.

Time

Change the current time.

Summertime

Set the time for Daylight Savings Time.

Smart Diagnosis

Use this to help troubleshoot errors or malfunctions. See the Smart Diagnosis section for more details.

Washer Pairing (Optional) ↻

Select this to (un)pair the Main Washer and the Mini Washer.

- This option is available when the Main Washer is used with the Mini Washer.

- 1 Press the **Power** button.
- 2 Swipe the display down to see the Settings screen and select More Settings. Select Washer Pairing from the Settings menu.

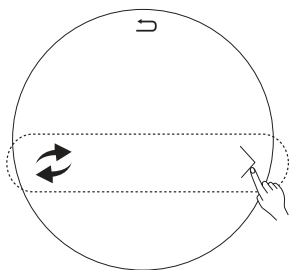

- 3 Press the **Pair** button.
- 4 When pairing is done, a popup window will appear in the display.

NOTE

- If pairing fails, follow these steps:

- 1 Make sure the mini washer is plugged in.
- 2 Reset the mini washer:
Press the **Power** button on the mini washer. Press and hold **Normal** and **Tub Clean** at the same time for 7 seconds.



- 3 If pairing fails several times, reset both the main washer and mini washer.
See the Factory Data Reset section for instructions on resetting the main washer.

- When '0' appears on the display, repeat Step 2.
- When the reset is complete, a number that is '1' or above is displayed. Try pairing again by referring to Washer Pairing.

Switching Between Main and Mini Washer

When the main and mini washers are paired, this function allows you to switch the controls between the two washers. Swipe down to open the Settings screen to select Main Washer or Mini Washer.

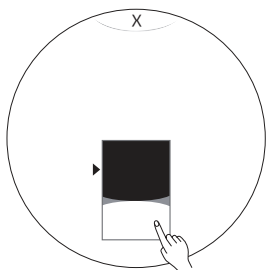

NOTE

- This feature is available only when the Mini Washer is connected.
- The cycles in Main Washer and Mini Washer are available at the same time and when both washers are running, the following display appears.

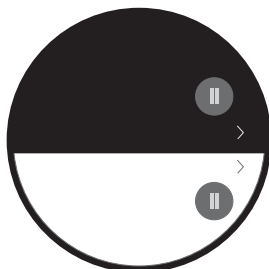

User Guide

Select this item to open instructions for operating the machine in the display window.

Program Update

Check to see if a newer version of the software is available.

Factory Data Reset

Select this to delete all the stored data and reset to the default settings.

- 1 Press the **Power** button.
- 2 Swipe down on the display to open the Settings screen and select **More Settings**. Select **Factory Data Reset** from the Settings menu.

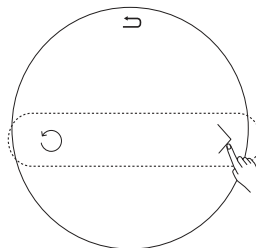

- 3 Press **Reset**.
- 4 Press the **Yes** button.

NOTE

- When a factory data reset is performed on the main washer, all data is deleted, including the Wi-Fi settings.
- The pairing can be delayed or fail due to communication problems between the Main Washer and Mini Washer or a Wi-Fi issue.

Download Cycles

This feature allows you to download new and specialized cycles that are not included in the appliance's standard cycles.

The appliance must be connected to the internet through a home Wi-Fi network to download cycles.

Downloading Cycles Using an Application

Follow these instructions after downloading and installing the LG Smart ThinQ application to your smartphone.

- 1 Press the **Power** button.
- 2 Using the LG Smart ThinQ app, check which cycles are currently downloaded.
 - If you try to download cycles on many different smart phones at the same time, the cycle displayed on your smart phone may be different from the actual cycle downloaded on the washing machine.
 - Press  in the application to check which cycle has been downloaded on the washing machine.
- 3 Select **Downloaded** button.
 - The available settings may vary depending on which cycle is downloaded.

NOTE

- You can download cycles after registering the appliance and configuring the Wi-Fi connection. For information on how to register the appliance and configure the Wi-Fi connection, refer to the Smart Functions section.
- Download desired cycles using the LG Smart ThinQ smartphone application. For more information on each cycle, refer to the application.
- Available cycles vary based on the washer model purchased.
- The downloadable cycles may change with updates to the LG Smart ThinQ application.

Downloading Cycles Directly

- 1 Press the **Power** button.
- 2 Swipe left on the display to get to the Download Cycles screen and press **Edit**.
 - You may need to delete one of the existing cycles to make room for a new downloaded cycle.
- 3 Press the add icon  to select a cycle to download.

Deleting a Downloaded Cycle

- 1 Press the **Power** button.
- 2 Swipe left on the display to get to the Download Cycles screen and press **Edit**.
 - You may need to delete one of the existing cycles to make room for a new downloaded cycle.
- 3 Press the  button on the cycle you want to delete.
- 4 Press the **OK** button.

SMART FUNCTIONS



Smart ThinQ Application

The Smart ThinQ application allows you to communicate with the appliance using a smartphone.

Installing Smart ThinQ Application

Search for the LG Smart ThinQ application from the Google Play Store or Apple App Store on a smart phone. Follow instructions to download and install the application.

Smart ThinQ Application Features

- For appliances with the  or  logo

Download Cycle

Set or download any preferred cycle and operate by remote control.

Tub Clean Coach

Check the appropriate Tub Clean period by washing frequency.

Energy Monitoring

Check the energy consumption of the recently used cycles and monthly average.

Smart Diagnosis™

This function provides useful information for diagnosing and solving issues with the appliance based on the pattern of use.

Settings

Various functions are available.

Push Alert

Turn on the Push Alerts to receive appliance status notifications. The notifications are triggered even if the LG Smart ThinQ application is off.

NOTE

- To verify the Wi-Fi connection, check that the **Wi-Fi**  icon on the control panel is lit.
- LG Smart ThinQ is not responsible for any network connection problems or any faults, malfunctions, or errors caused by network connection.
- The machine supports 2.4 GHz Wi-Fi networks only.
- If the appliance is having trouble connecting to the Wi-Fi network, it may be too far from the router. Purchase a Wi-Fi repeater (range extender) to improve the Wi-Fi signal strength.
- The Wi-Fi connection may not connect or may be interrupted because of the home network environment.
- The network connection may not work properly depending on the internet service provider.
- The surrounding wireless environment can make the wireless network service run slowly.
- This information is current at the time of publication. The application is subject to change for product improvement purposes without notice to users.

Wireless LAN Module

Model	TWFM-K304D
Frequency Range	2412~2462 MHz
Output Power (Max.)	IEEE 802.11 b : 19.58 dBm
	IEEE 802.11 g : 19.84 dBm
	IEEE 802.11 n(HT20) : 18.77 dBm
	IEEE 802.11 n (HT40) : 17.25 dBm

ZigBee Module Specifications

Model	EBR81777301
Frequency Range	2405~2480 MHz
Output Power (Max.)	IEEE 802.11 b : 2.3 dBm

FCC Notice

- For transmitter module contained in this product

This equipment has been tested and found to comply with the limits for a Class B digital device, pursuant to Part 15 of the FCC Rules. These limits are designed to provide reasonable protection against harmful interference in a residential installation. This equipment generates, uses, and can radiate radio frequency energy and, if not installed and used in accordance with the instructions, may cause harmful interference to radio communications. However, there is no guarantee that interference will not occur in a particular installation. If this equipment does cause harmful interference to radio or television reception, which can be determined by turning the equipment off and on, the user is encouraged to try to correct the interference by one or more of the following measures:

- Reorient or relocate the receiving antenna.
- Increase the separation between the equipment and the receiver.
- Connect the equipment to an outlet on a circuit different from that to which the receiver is connected.
- Consult the dealer or an experienced radio/TV technician for help.

This device complies with part 15 of the FCC Rules. Operation is subject to the following two conditions:

- 1) This device may not cause harmful interference and
- 2) This device must accept any interference received, including interference that may cause undesired operation of the device.

Any changes or modifications in construction of this device which are not expressly approved by the party responsible for compliance could void the user's authority to operate the equipment.

FCC RF Radiation Exposure Statement

This equipment complies with FCC radiation exposure limits set forth for an uncontrolled environment. This transmitter must not be co-located or operating in conjunction with any other antenna or transmitter.

This equipment should be installed and operated with a minimum distance of 20 cm (7.8 inches) between the antenna and your body. Users must follow the specific operating instructions for satisfying RF exposure compliance.

Industry Canada Statement

- For transmitter module contained in this product

This device complies with Industry Canada's applicable licence-exempt RSSs. Operation is subject to the following two conditions:

- 1) This device may not cause interference; and
- 2) This device must accept any interference, including interference that may cause undesired operation of the device.

IC Radiation Exposure Statement

This equipment complies with IC radiation exposure limits set forth for an uncontrolled environment.

This equipment should be installed and operated with a minimum distance of 20 cm (7.8 inches) between the antenna and your body.

NOTE

- The manufacturer is not responsible for any radio or TV interference caused by unauthorized modifications to this equipment. Such modifications could void the user's authority to operate the equipment.

Open Source Software Notice Information

LG Electronics will also provide open source code to you on CD-ROM for a charge covering the cost of performing such distribution (such as the cost of media, shipping, and handling) upon email request to opensource@lge.com. This offer is valid for three (3) years from the date on which you purchased the product.



To obtain the source code under GPL, LGPL, MPL, and other open source licenses, that is contained in this product, please visit <http://opensource.lge.com>.

In addition to the source code, all referred license terms, warranty disclaimers and copyright notices are available for download.

Smart Diagnosis™ Function

Should you experience any problems with the appliance, it has the capability of transmitting data via your telephone to the LG Customer Information Center. NFC or Wi-Fi equipped models can also transmit data to a smartphone using the LG Smart ThinQ application.

Smart Diagnosis™ through the Customer Information Center

- For appliances with the  or  logo

This method allows you to speak directly to our trained specialists. The specialist records the data transmitted from the appliance and uses it to analyze the issue, providing a fast and effective diagnosis.

- 1 Call the LG Electronics Customer Information Center at:
(LG U.S.A.) 1-800-984-6306
- 2 Swipe the display down to see the Settings screen and select **More Settings**. Select **Smart Diganosis** from the Settings menu and press the **Start** button.
- 3 When instructed to do so by the call center agent, hold the mouthpiece of your phone over the **Power** button. Hold the phone no more than one inch from (but not touching) the machine.

NOTE

- Do not touch any other buttons or icons on the display screen.

- 4 Keep the phone in place until the tone transmission has finished. The display will count down the time.
- 5 Once the countdown is over and the tones have stopped, resume your conversation with the call center agent, who will then be able to assist you in using the information transmitted for analysis.

NOTE

- Smart Diagnosis™ cannot be activated unless the appliance can be turned on using the **Power** button. If the appliance cannot be turned on, troubleshooting must be done without using Smart Diagnosis™.
- For best results, do not move the phone while the tones are being transmitted.
- If the call center agent is not able to get an accurate recording of the data, you may be asked to try again.
- The Smart Diagnosis™ function depends on the local call quality.
- Bad call quality may result in poor data transmission from your phone to the call center, which could cause Smart Diagnosis™ to malfunction.

Smart ThinQ Smart Diagnosis™

- For appliances with the  or  logo

Use the Smart Diagnosis feature in the Smart ThinQ application for help diagnosing issues with the appliance without the assistance of the LG Customer Information Center.

Follow the instructions in the Smart ThinQ application to perform a Smart Diagnosis using your smartphone.

NOTE

- Smart Diagnosis™ cannot be activated unless the appliance can be turned on using the **Power** button. If the appliance cannot be turned on, troubleshooting must be done without using Smart Diagnosis™.

MAINTENANCE

WARNING

To reduce the risk of fire, electric shock, or injury to persons, read and follow this entire owner's manual, including the Important Safety Instructions.

- Unplug the washer before cleaning to avoid the risk of electric shock. Failure to follow this warning can cause serious injury, fire, electric shock, or death.
- Do not use volatile substances (benzene, paint thinner, alcohol, acetone, etc.) or detergents with strong chemical components when cleaning the washer. Doing so may cause discoloration or damage to the machine, or may cause a fire.

NOTE

- Never use harsh chemicals, abrasive cleaners, or solvents to clean the washer. They will damage the finish.

Regular Cleaning

Care After Wash

After the cycle is finished, wipe the door and the inside of the door seal to remove any moisture.

- Leave the door open to dry the drum interior.
- Wipe the body of the washer with a dry cloth to remove any moisture.

Cleaning the Exterior

Proper care of your washer can extend its life.

Door:

Wash with a damp cloth on the outside and inside and then dry with a soft cloth.

Exterior:

- Immediately wipe off any spills.
- Wipe with a damp cloth.
- Do not touch the surface or the display with sharp objects.

Care and Cleaning of the Interior

- Use a towel or soft cloth to wipe around the washer door opening and door glass.
- Always remove items from the washer as soon as the cycle is complete. Leaving damp items in the washer can cause wrinkling, color transfer, and odor.
- Run the Tub Clean cycle once a month, or more often if needed, to remove detergent buildup and other residue.

Tub Clean Cycle

- Some environmental and usage conditions can cause a residue to build up in the drum over time and can lead to a mildewy or musty smell. Periodic use of this cycle helps to prevent mildew or a musty smell. Run the Tub Clean cycle once a month, or more often under heavy use conditions or if odor is present.

- 1 Remove any clothing from the tub.
- 2 Put in the manufacturer's recommended amount of a tub cleaning agent.
- 3 Close the door and press the **Power** button to turn the washer on.
- 4 Select the **Tub Clean** cycle from the download cycles to clean the drum.
- 5 Press the **Start/Pause** button to begin the cycle. Selecting any other cycle after Tub Clean has been selected will cause the Tub Clean cycle to be cancelled.
- 6 After the cycle ends, open the door and allow the drum interior to dry completely.

CAUTION

- If children are present, be careful not to leave the door open for too long.

NOTE

- Clean the drum regularly using the Tub Clean option for optimal washing. After approximately 30 cycles, the Main Washer Tub Clean notification will appear to inform that it is time to clean the drum.
- Once a Tub Clean cycle is run, the Main Washer Tub Clean notification will disappear until the next Tub Clean is due.
- To reset the Tub Clean notification without running a Tub Clean cycle, simply run a wash cycle.

Cleaner	Instructions
Tub cleaner	Place directly into washer drum.
Lime scale remover	
Liquid chlorine bleach	
Powdered cleaner	
Cleaning tablets	

NOTE

- Never load laundry while using Tub Clean. The laundry may be damaged or contaminated with cleaning products. Make sure to run the Tub Clean cycle only when the drum is empty.
- Leave the door open after finishing the laundry, to keep the drum clean.
- Tub Clean should be repeated monthly.
- If mildew or musty smell already exists, run Tub Clean once a week for three consecutive weeks.
- For other drum cleaning products, follow the cleaner manufacturer's instructions and recommendations.
- Do not exceed the manufacturer's recommended amount when manually dispensing powdered oxygen-based bleach or detergent. Powdered detergent may remain in the drum after cleaning.

Automatic Alert for Tub Clean

When the power is on and the 'Tub Clean' message blinks on the display, it means the washer drum needs cleaning. Use the Tub Clean cycle to clean the washer drum. The frequency of the automatic alert's appearance depends on how often the washer is used, however the message will generally appear every one to two months.

Removing Mineral Buildup

In areas with hard water, mineral scale can form on internal components of the washer. Periodically clean the mineral buildup on the internal components to extend the lifespan of the washer. Use of a water softener is recommended in areas with hard water.

- Use a descaler, such as Washer Magic®, to remove visible mineral buildup on the washer drum.

After descaling, always run the Tub Clean cycle before washing clothing.

- Mineral scale and other spots may be removed from the stainless steel drum using a soft cloth soaked in stainless steel cleaner.
- Do not use steel wool or abrasive cleaners.

NOTE

- If you use a descaler or tub cleaner during the Tub Clean cycle, use the Rinse+Spin cycle to rinse the washer drum before running your next wash cycle.

Cleaning the Door Seal

Clean the door seal once a month to prevent build-up of dirt.

- 1 **Wear rubber gloves and protective goggles.**
- 2 **Dilute 3/4 cup (177 ml) of liquid chlorine bleach in 1 gallon (3.8 L) of water.**
- 3 **Wipe around the door seal.**
Soak a sponge or a soft cloth in this diluted solution and wipe all around the door seal.
- 4 **Wipe dry.**
After cleaning, wipe up any moisture with a dry towel or cloth.
- 5 **Leave the door open to allow the door seal to dry completely.**

CAUTION

- Cleaning the door seal with undiluted bleach may cause malfunction of the door seal and washer parts. You must add water to the bleach before using it.

Cleaning the Water Inlet Filters

If the washer does not fill properly, an error message will show on the display. The inlet valve filter screens could be plugged by hard water scale, sediment in the water supply, or other debris.

CAUTION

- The inlet screens protect the delicate parts of the inlet valve from being damaged by particles that could enter the valves with the water supply. Operating the washer with these filters removed could cause a valve to stick open resulting in flooding and/or property damage.
- Do not use the washer without the inlet filters. If you use the washer without the inlet filters it will cause leaks and malfunction.
- If you use the washer in an area with hard water, the inlet filter may clog due to lime buildup.

- 1 **Turn off both water faucets completely.**
- 2 **Unscrew the hot and cold water hoses from the back of the washer.**
- 3 **Carefully remove the filters from the water valves.**
- 4 **Remove foreign objects and soak the filters in white vinegar or a lime scale remover.**
If using a lime scale remover, follow the manufacturer's instructions. Be careful not to damage the filters while cleaning them.
- 5 **Rinse filters thoroughly and press them back into place.**
- 6 **Flush then reattach the water hoses.**
Before reattaching the hoses, flush the hoses and water lines by running several gallons of water into a bucket or drain, preferably with the faucets wide open for maximum flow.

NOTE

- An '[IE]' message may blink on the display when the water pressure is weak or an inlet filter is clogged with dirt. Clean the inlet filter.

Cleaning the Drain Pump Filter

The washer fails to drain if the drain pump filter is clogged. Periodically clean the drain filter to prevent clogging with foreign objects.

! WARNING

- Opening the drain filter will result in water overflowing if there is water in the washer drum. Use a bucket if the drum is not completely drained before you open the drain filter.
- Using the washer without the drain filter or with an incorrectly assembled drain filter may cause leaks or malfunctioning of the washer.

- 1 Turn off the machine and pull out the plug.
- 2 Press on the circle to open the lower cover as shown below.

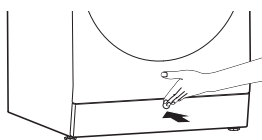

- 3 Unclip the drain hose and remove the plug from the drain hose to drain the remaining water.

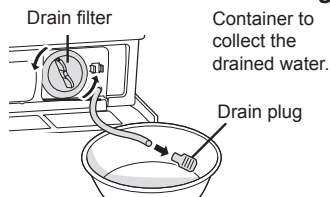

- 4 Clean the pump filter and opening. Twist the pump filter counterclockwise to remove.

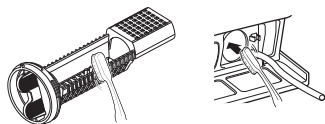

- 5 After cleaning, assemble the hose cap and the pump filter in the original positions.

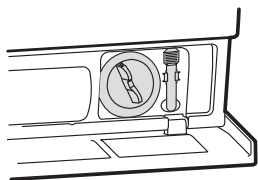

- 6 Close the lower cover.

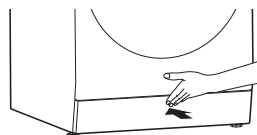

NOTE

- An '[OE]' message blinks on the display when the drain pump filter is clogged with dirt. Clean the drain pump filter.

Cleaning Auto Dispense Tray

Clean the Auto Dispense tray before refilling it or if detergent or softener have hardened with lack of use.

- 1 Press on the circle to open the lower cover as shown below.
- 2 Push in on the top of the Auto Dispense tray to slide it out and use the handle to remove the tray.

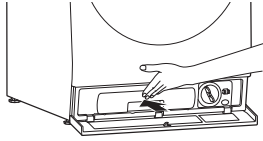

- 3 Turn the reservoir caps counterclockwise to remove them.



- 4 Turn the check valves on the back of the tray counterclockwise to remove them.

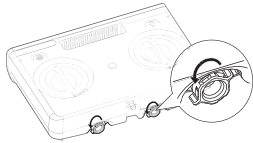

- 5 Clean the Auto Dispense tray and the check valves under running water.

- 6 Assemble the check valves by inserting them and turning them clockwise.
- 7 Fill the detergent reservoir with liquid HE detergent and the softener reservoir with liquid fabric softener. Insert the caps on the reservoirs and turn clockwise until tight.
- 8 Insert the Auto Dispense tray back in the machine until it clicks. Close the lower cover.

Care in Cold Climates

Storing the Washer

If the washer will not be used for an extended period of time and is in an area that could be exposed to freezing temperatures, perform the following steps to protect the washer from damage.

- 1 Turn off the water supply.
- 2 Disconnect hoses from water supply and drain water from hoses.

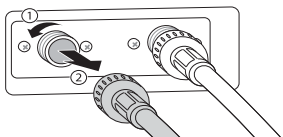

- 3 Plug the power cord into a properly grounded electrical outlet.
- 4 Add 1 gallon of nontoxic recreational vehicle (RV) antifreeze to the empty drum and close the door. Never use automotive antifreeze.
- 5 Press the **Power** button, then select **Spin**.
- 6 Press the **Start/Pause** button to start the drain pump.
- 7 Allow the drain pump to run for one minute, then press the **Power** button to shut off the washer. This will expel some of the antifreeze, leaving enough to protect the washer from damage.
- 8 Unplug the power cord, dry the drum interior with a soft cloth, and close the door.
- 9 Store the washer in an upright position.
- 10 To remove the antifreeze from the washer after storage, run a complete Speed Wash cycle using detergent.
Do not add laundry to this cycle.

When the Water Line is Frozen

- 1 Turn off the faucets connected with the water lines.
- 2 Pour hot water on the frozen faucets to thaw the water lines and remove them.
- 3 Immerse the water lines in hot water to thaw them.
- 4 Connect the water lines with the water inlets of the washer and with the faucets.
See Connecting the Water Lines for details.
- 5 Turn on the faucets.
- 6 Press the **Power** button.
- 7 Press the **Spin** cycle.
- 8 Press the **Start/Pause** button. Verify the water fills properly.

When the Drain Line is Frozen

- 1 Pour hot water in the washer drum and close the door. Wait for 1-2 hours.
- 2 Press the **Power** button after thawing.
- 3 Press the **Spin** cycle to select draining and spinning.
- 4 Press the **Start/Pause** button. Check to make sure the water drains.

TROUBLESHOOTING

FAQs: Frequently Asked Questions

Q: Why does my washer make loud banging noises while it is filling with water?

A: This is actually a problem with the plumbing in your home. When the water valve in the washer shuts off, it can cause pipes in your home to move, resulting in a loud banging noise. This effect, called water hammer, can be reduced by installing an item called a water hammer arrestor. Add-on arrestors can be purchased through your local hardware or home improvement store.

Q: Why is there so little water in my washer? How can it clean the clothes?

A: HE (High-Efficiency) washers are designed to properly wash your laundry while using a minimum amount of water and energy. Because the water volume is low, the small amount of detergent used is more concentrated in the water, resulting in excellent cleaning performance.

Q: When I press a button, why does my washer beep and then nothing happens?

A:

- The Control Lock feature is turned on. To turn off Control Lock, turn the washer on, then swipe down to open the Settings screen. Touch the Control Lock button to turn off Control Lock.
- Power or Signal is off.

Q: Where should I pour my OxiClean™ or other powdered laundry products when doing my laundry?

A:

- If you are using powdered laundry detergent, you must dispense it manually using the manual dispenser cup. See the Dispensing Detergent Manually section. Powdered laundry agents such as OxiClean™ or powdered color safe bleach should also be put in the manual dispenser or put directly into the tub. These products can be put in the empty tub before loading or on top of the laundry after loading the machine. Do not use liquid chlorine bleach with this machine.

Before Calling for Service

The washer is equipped with an automatic error-monitoring system to detect and diagnose problems at an early stage. If the washer does not function properly or does not function at all, check the following before you call for service.

Noises You Might Hear

Noise	Possible Cause	Solutions
Spraying or Hissing	Water spraying or circulating during the cycle.	Normal Operation
Humming or Gurgling	Drain pump is pumping water from the washer at times during a cycle.	Normal Operation
Water sloshing	A liquid in the balance ring around the wash basket helps the basket spin smoothly.	Normal Operation
Water being added after the washer has already begun to operate	The washer adapts to the load size and type to add more water to the cycle as needed.	Normal Operation
	The wash load may be unbalanced. If the washer senses that the load is unbalanced, it will stop and refill to redistribute the load.	
	The washer may be diluting laundry additives to add to the wash load.	
Rattling and clanking noise	Foreign objects, such as keys, coins, or safety pins may be in drum or pump.	Stop washer, check drum and drain filter for foreign objects. If noise continues after washer is restarted, call for service.
Thumping sound	Heavy wash loads may produce a thumping sound.	This is normal. If sound continues, washer is probably out of balance. Stop and redistribute wash load.
	Wash load may be out of balance.	Pause the cycle and redistribute the load.
Vibrating noise	Packaging materials were not removed.	See the Unpack and Remove Shipping Material information in the Installation section.
	Wash load may be unevenly distributed in the drum.	Pause the cycle and redistribute the load.
	Not all leveling feet are resting firmly and evenly on the floor.	See Level the Washer in the Installation section.
	Floor not rigid enough.	Make sure that the floor is solid and does no flex. See Flooring in the Installation Requirements section.
Squeaking noise	Packaging materials were not removed.	See the Unpack and Remove Shipping Material information in the Installation section.
Banging noise when washer is filling with water (Water Hammer)	Plumbing in the home moves or flexes when the water valves in the washer shut off.	Water hammer is not caused by a defect in the washer. Install water hammer arrestors (purchased separately at hardware or home improvement store) between the fill hose and the washer for best results.
	Household water supply pressure is very high.	Adjust household water supply regulator to a lower pressure or contact a plumber.

Operation

Problem	Possible Cause	Solutions
Water leaking	Inlet hose connection is loose at faucet or washer.	Check hoses for leaks, cracks and splits. Check and tighten hose connections.
	House drain pipes are clogged.	The washer pumps out water very rapidly. Check for water backing up out of the drain pipe during drain. If water is seen coming out of the drain, check for proper drain hose installation and check for restrictions in the drain. Contact a plumber to repair drain pipe.
	Drain hose has come out of drain or is not inserted far enough.	Tie drain hose to inlet hose or standpipe to prevent it from coming out during drain. For smaller drain pipes, insert the drain hose into the pipe as far as the drain hose flange. For larger drain pipes, insert the drain hose into the pipe 1-2 inches past the flange.
	A large item such as a pillow or blanket is above the top of the tub.	Use the Bulky cycle for large or bulky items. Use extra care and never wash more than half a load of items that float, such as pillows. Stop the washer and check the load. Make sure the load does not crest above the top edge of the tub.
Water leaks every load	Hoses not installed correctly.	Normal Operation
Washer will not drain water	Kinked drain hose.	Ensure that the drain hose is not kinked.
	Drain located improperly.	Make sure that the drain hose is no more than 5 ft. away from the washer.
Washer will not turn on	Power cord is not properly plugged in.	Make sure that the plug is plugged securely into a grounded, 3-prong, 120 VAC, 60 Hz outlet.
	House fuse is blown, circuit breaker has tripped, or power outage has occurred.	Reset circuit breaker or replace fuse. Do not increase fuse capacity. If the problem is a circuit overload, have it corrected by a qualified electrician.
Wash cycle time is longer than usual	The washer automatically adjusts the wash time for the amount of laundry, water pressure and other operating conditions.	This is normal. The washer adjusts cycle time automatically to provide optimal results for the selected cycle. The time remaining shown in the display is only an estimate. Actual time may vary.

Problem	Possible Cause	Solutions
Incomplete or no dispensing of detergent	Detergent compartments clogged from incorrect filling.	Make sure that detergent and additives are put into the correct Auto Dispense reservoirs. Make sure that the Auto Dispense tray is properly installed before the start of the cycle.
	Too much detergent used.	If dispensing manually, make sure that the suggested amount of detergent is used per the manufacturer's recommendations. You may also dilute the detergent with water to the maximum fill line on the reservoir to avoid clogging. Use only HE (High-Efficiency) detergent. NOTE: Always use as little detergent as possible. High-Efficiency washers need very little detergent to achieve optimum results. Using too much detergent will cause poor wash and rinse performance and may contribute to odors in washer.
	Insufficient water supply.	Make sure that both hot and cold water faucets are turned on all the way.
	Normal residue.	Detergent may have hardened due to lack of use. If this residue builds up it can interfere with normal dispensing of products. Refer to the cleaning instructions.
Washer will not operate	Control panel has powered off due to inactivity.	This is normal. Press the Power button to turn the washer on.
	Washer is unplugged.	Make sure cord is plugged securely into a working outlet.
	Water supply is turned off.	Turn both hot and cold faucets fully on.
	Controls are not set properly.	Make sure the cycle was set correctly, close the door and press the Start/Pause button.
	Door is open.	The washer will not operate if the door is open. Close the door and make sure that nothing is caught in the door seal area preventing it from closing completely.
	Circuit breaker/fuse is tripped/blown.	Check house circuit breakers/fuses. Replace fuses or reset breaker. The washer should be on a dedicated branch circuit. The washer will resume the cycle where it stopped once power is restored.
	Control needs to be reset.	Press the Power button, then re-select the desired cycle and press the Start/Pause button.
	Start/Pause was not pressed after a cycle was set.	Press the Power button then re-select the desired cycle and press the Start/Pause button. The washer will shut off if the Start/Pause button is not pressed within 60 minutes.
	Extremely low water pressure.	Check another faucet in the house to make sure that household water pressure is adequate.
	Washer is too cold.	If the washer has been exposed to temperatures below freezing for an extended period of time, allow it to warm up before pressing the Power button. Otherwise, the display will not come on.

Problem	Possible Cause	Solutions
Washer not filling properly	Filter clogged.	Make sure the inlet filters on the fill valves are not clogged. Refer to the filter cleaning instructions.
	Inlet hoses may be kinked.	Check that inlet hoses are not kinked or clogged.
	Energy efficiency.	This is a High-Efficiency (HE) washer. As a result, the water level settings for this washer may be different than for conventional washers.
	Insufficient water supply.	Make sure that both hot and cold water faucets are turned on all the way.
	The washer door is open.	The washer will not operate if the door is open. Close the door and make sure that nothing is caught in the door seal area preventing it from closing completely.
Water level is too low/ No water is visible in the drum	Energy efficiency	This is a High-Efficiency (HE) washer. As a result, the water level settings for this washer may be different than on your previous washer. The water will not normally cover the clothes. The fill level is optimized for the wash motion to achieve the best wash performance.
Oversudsing	Too much detergent or unsuitable detergent may cause excessive foaming which may result in water leaks.	If using the Auto Detergent function, change the dispense amount in the Settings menu under More Settings. See the Auto Dispense section for more information.
		Clean the Auto Dispense tray and make sure to use an HE detergent.
		Do not put detergent in the manual dispenser while the Auto Detergent function is turned on.
Buttons do not function properly	Buttons are disabled when the door is open.	Press again after closing the door.
A shortage alert appears even after you filled the dispensers for the detergent and softener.	The machine is not level.	Make sure that the machine is level and all four feet rest firmly on the ground.
	Reservoirs were refilled before the shortage notification was sent.	The washing machine detects and sends shortage notifications at the end of the wash cycle.
Drying performance is poor.	Water is not properly supplied. The water is used for auto-cleaning of lint-filter on drum during the drying.	Make sure the water supply tap is open.
	Water does not properly drain.	Make sure the drain filter is not clogged.
	The appliance is overloaded.	Check the load capacity for the selected cycle. If necessary, add a Time Dry cycle.
	The spin speed is too low.	Select the highest spin speed allowed for the wash cycle.

Performance

Problem	Possible Cause	Solutions
Wrinkling	Washer not unloaded promptly.	Always remove items from the washer as soon as the cycle is complete.
	Washer overloaded.	The washer can be fully loaded, but the drum should not be tightly packed with items. The door of the washer should close easily.
	Hot and cold water inlet hoses are reversed.	Hot water rinse can set wrinkles in garments. Check the inlet hose connections.
	Clothes are over-dried.	Make sure select suitable drying cycle.
	Clothes are left in the drum for a long time after drying.	Remove laundry from the drum as soon as possible after the cycle ends.
Staining	Liquid chlorine bleach or softener was added directly to the wash load in the drum.	Do not use liquid chlorine bleach with this model. Softener should be put in the Auto Dispense tray.
	Washer was not unloaded promptly.	Always remove items from the washer as soon as possible after the cycle is complete.
	Clothes were not properly sorted.	Always wash dark colors separately from light colors and whites to prevent discoloration. Never wash heavily soiled items with lightly soiled items.
Poor stain removal	Proper options not selected.	Heavier soils and tougher stains may require extra cleaning power. Select the Soak or Stain Care feature to boost the cleaning power of the selected cycle.
	Previously set stains.	Articles that have previously been washed may have stains that have been set. These stains may be difficult to remove and may require hand washing or pre-treating to aid in stain removal.
Musty or mildewy odor in washer	Incorrect or too much detergent has been used.	Use only High-Efficiency (HE) detergent in accordance with the manufacturer's instructions.
	Inside of drum was not cleaned properly.	Run the Tub Clean cycle regularly.
	Lint filters have not been cleaned for a long time.	Make sure the water supply tap is opened.
Strange odors coming from washer	Dryer heating.	As the dryer heats, it may initially cause a slight odor. This is normal and does not affect performance.
	Newly installed washer.	Smell comes from the rubber attached to the washer door. It will eventually dissipate after first couple of wash cycles.
	Build-up of residue on washer, foreign object in door gasket, clogged drain pump filter, clogged or kinked drain hose.	Periodically clean the gasket. Mold and foreign substances inside the gasket may produce mildew or musty smells.
		Clean the drain pump filter regularly. Foreign substances on the drain pump filter may produce mildew or musty smells.
		If the drain hose is not installed properly, the odor may be emitted because of a backflow of drainage into the tub. Make sure that the drain hose is not kinked or clogged.

Error Codes

Error Code	Possible Cause	Solutions
Washer fills with water slowly or not at all, or [IE]	Water supply faucets are not fully open.	Make sure that the water faucets are fully open.
	Water line hoses are kinked, pinched, or crushed.	Make sure that the hoses are not kinked or pinched. Be careful when moving the washer during cleaning and maintenance.
	Water inlet filters are clogged.	Clean the inlet filters. See Maintenance in the Care and Cleaning section.
	Water supply pressure to faucet or house is too low.	Check another faucet in the house to make sure that household water pressure is adequate and flow is not restricted. Disconnect the inlet hose from the washer and run a few gallons of water through the hose to flush the water supply lines. If flow is too low, contact a plumber to have the water lines repaired.
	Water supply connected with leaklimiting hoses.	Hoses designed to limit leaks can trip falsely and prevent the washer from filling. The use of leak limiting hoses is not recommended.
[UE]	If the balance is not successful, this error will be displayed.	The automatic attempt to rebalance the load was not successful. The cycle has been paused to allow the load to be manually adjusted.
	The load is too small.	Small loads may need additional items to be added to allow the washer to balance the loads.
	Heavy articles are mixed with lighter items.	The load may have heavy items loaded with lighter items. Always try to wash articles of somewhat similar weight to allow the washer to evenly distribute the weight of the load for spinning.
	The load is out of balance.	Manually redistribute the load if articles have become tangled preventing the automatic distribution from working properly.

Error Code	Possible Cause	Solutions
The tub does not rotate or [dE],[dE1],[dE2]	The door is not secured.	Close and secure the door. If the message keeps appearing, unplug the power cord and call for service.
[dE4]	Door sensor has malfunctioned.	
Water in the washer drains slowly or not at all and [OE]	Drain hose is kinked, pinched, or clogged	Make sure the drain hose is free of clogs, inks, etc., and is not pinched behind or under the washer.
[OE]	Drain discharge is more than 96 inches (2.4 m) above bottom of washer.	Use the drain 96 inches (2.4 m) above the bottom of the washer.
[tE]	Control error.	Unplug the washer and wait 60 seconds. Reconnect power and try again. If the error reappears, call for service.
[FE]	Water level is too high due to a faulty water valve.	Close the water faucets, unplug the washer, and call for service.
[PE]	The water level sensor is not working correctly.	Close the water faucets, unplug the washer, and call for service.
[LE]	A motor error has occurred.	Allow the washer to stand for 30 minutes and then restart the cycle. If the LE error code persists, call for service.
[LE1]	Overload in fan-motor.	
[LE2]	Overload in compressor.	
[PF]	The water level too low or high compared with the size of the load.	Do not add more than the manufacturer's recommended amount of detergent.
[FF]	Inlet hose, drain hose or drain pump frozen.	See the Care in Cold Climates section for instructions.
[dHE]	Does not dry.	Call for service.

WARRANTY (USA)

Should your LG Washer fail due to a defect in materials or workmanship under normal home use, during the warranty period set forth below, LG will at its option repair or replace the product. This limited warranty is valid only to the original retail purchaser of the product and applies only when purchased and used within the United States, including U.S. Territories. Proof of original retail purchase is required to obtain warranty service under this limited warranty.

Warranty Period	Scope of Warranty	Remark
One (1) year from date of original retail purchase	Any internal /functional Parts and Labor	LG will provide parts and labor to repair or replace defective parts.
Twenty (20) years from date of original retail purchase	DD Motor (Stator, Rotor, Hall Sensor)	Parts only. Customer will be responsible for any labor or in-home service to replace defective parts.
Limited Lifetime	Stainless Steel Drum	

- Replacement products and parts are warranted for the remaining portion of the original warranty period or ninety (90) days, whichever is greater.
- Replacement products and parts may be new or remanufactured.

THIS WARRANTY IS IN LIEU OF ANY OTHER WARRANTY, EXPRESS OR IMPLIED, INCLUDING WITHOUT LIMITATION, ANY WARRANTY OF MERCHANTABILITY OR FITNESS FOR A PARTICULAR PURPOSE. TO THE EXTENT ANY IMPLIED WARRANTY IS REQUIRED BY LAW, IT IS LIMITED IN DURATION TO THE EXPRESS WARRANTY PERIOD ABOVE. NEITHER THE MANUFACTURER NOR ITS U.S. DISTRIBUTOR SHALL BE LIABLE FOR ANY INCIDENTAL, CONSEQUENTIAL, INDIRECT, SPECIAL, OR PUNITIVE DAMAGES OF ANY NATURE, INCLUDING WITHOUT LIMITATION, LOST REVENUES OR PROFITS, OR ANY OTHER DAMAGE WHETHER BASED IN CONTRACT, TORT, OR OTHERWISE.

Some states do not allow the exclusion or limitation of incidental or consequential damages or limitations on how long an implied warranty lasts, so the above exclusion or limitation may not apply to you. This warranty gives you specific legal rights and you may also have other rights that vary from state to state.

THIS LIMITED WARRANTY DOES NOT COVER:

- Service trips to deliver, pick up, or install or repair the product; instruction to the customer on operation of the product; repair or replacement of fuses or correction of wiring or plumbing, or correction of unauthorized repairs/installation.
- Failure of the product to perform during power failures and interrupted or inadequate electrical service.
- Damage caused by leaky or broken water pipes, frozen water pipes, restricted drain lines, inadequate or interrupted water supply or inadequate supply of air.
- Damage resulting from operating the product in a corrosive atmosphere or contrary to the instructions outlined in the product's owner's manual.
- Damage to the product caused by accidents, pests and vermin, lightning, wind, fire, floods, or acts of God.
- Damage or failure caused by unauthorized modification or alteration, or if it is used for other than the intended purpose, or any water leakage where the unit was not properly installed.

- Damage or failure caused by incorrect electrical current, voltage, or plumbing codes, commercial or industrial use, or use of accessories, components, or consumable cleaning products that are not approved by LG.
- Damage caused by transportation and handling, including scratches, dents, chips, and/or other damage to the finish of your product, unless such damage results from defects in materials or workmanship and is reported within one (1) week of delivery.
- Damage or missing items to any display, open box, discounted, or refurbished product.
- Products with original serial numbers that have been removed, altered, or cannot be readily determined. Model and serial numbers, along with original retail sales receipts, are required for warranty validation.
- Increases in utility costs and additional utility expenses.
- Repairs when your product is used for other than normal and usual household use (e.g. commercial use, in offices and recreational facilities) or contrary to the instructions outlined in the product's owner's manual.
- Costs associated with removal of your product from your home for repairs.
- The removal and reinstallation of the product if it is installed in an inaccessible location or is not installed in accordance with published installation instructions, including LG's owner's and installation manuals.
- Damage resulting from misuse, abuse, improper installation, repair, or maintenance. Improper repair includes use of parts not approved or specified by LG.

Strange vibration or noise caused by not removing transit bolts or tub support. ➔

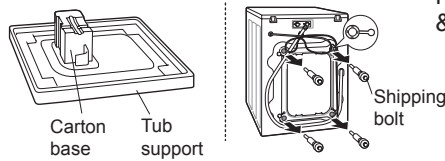

Remove the shipping bolts & tub support.

Leakage caused by dirt (hair, lint) on seal and door glass. ➔

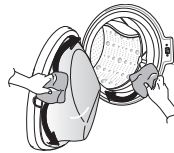

Clean the seal & door glass.

Not draining because of clogged pump filter. ➔

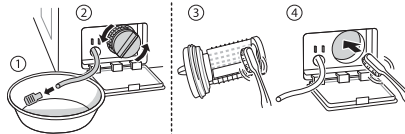

Clean the pump filter.

Water is not filling because water inlet valve filters are clogged or water inlet hoses are kinked. ➔

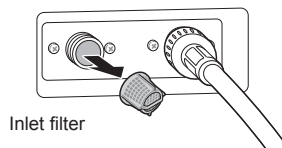

Clean the inlet valve filter or reinstall the water inlet hoses.

Laundry is hot or warm after washing because the inlet hoses are installed in reverse. ➔

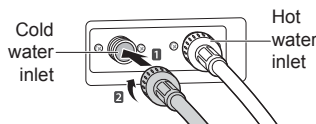

Reinstall the inlet hoses.

Water is not supplied because the water tap is not turned on. ➔

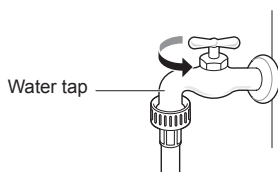

Turn on the water tap.

Leakage caused by improper installation of drain hose or clogged drain hose. ➔

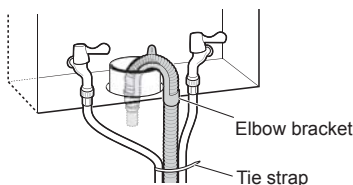

Reinstall the drain hose.

Leakage caused by improper installation of water inlet hose or using other brand inlet hoses. ➔

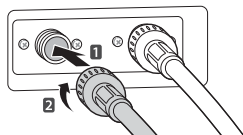

Reinstall the inlet hose.

No power supplied due to loose connection of power cord or electrical outlet problem. ➔

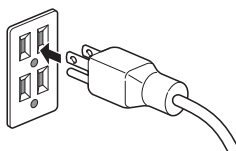

Reconnect the power cord or change the electrical outlet.

Service trips to deliver, pick up, install the product or for instruction on product use. The removal and reinstallation of the Product. ➔

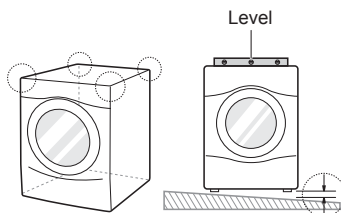

The warranty covers manufacturing defects only. Service resulting from improper Installation is not covered.

If all screws are not installed properly, it may cause excessive vibration (Pedestal model only). ➔

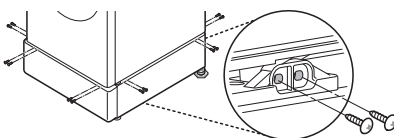

Install 4 screws at each corner (Total 16EA).

Water hammering (banging) noise when washing machine is filling with water. ➔

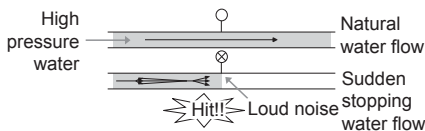

Adjust the water pressure by turning down the water valve or water tap in the home.

The cost of repair or replacement under these excluded circumstances shall be borne by the consumer.

TO OBTAIN WARRANTY SERVICE AND ADDITIONAL INFORMATION

For additional product information, visit the LG website at <http://www.LGSIGNATURE.com>

For assistance using this product or to schedule service, contact LG Electronics at 1-800-984-6306.

For further assistance, write: LG Electronics, 201 James Record Road, Huntsville, Alabama 35813

LG SIGNATURE

LG Customer Information Center

For inquiries or comments,
visit www.LGSIGNATURE.com or call:

1-800-984-6306 U.S.A.

Register your product Online!

www.LGSIGNATURE.com