

PARAMOUNT RANGE SERIES (SGR)

30 in. 4.2 cu. ft. Range with 4 Burner Cooktop and Convection Gas Oven

ZLINE
ATTAINABLE LUXURY®

SGR30 Stainless Steel

All 30" models come standard with 1 brass dual burner



FEATURES AND BENEFITS

Italian-Made Auto Re-ignition Burners: 4 Italian-made gas burners utilize automatic re-ignition innovation for improved temperature control and cooktop safety.

Horizon Oven Window: Keep a watchful eye on your baking dishes through ZLINE's Horizon oven door design that features a large viewing window.

Stainless Steel Oven Burners: Tubular bake and broil burners are designed for optimal gas combustion that allows for even heat distribution for an ideal baking experience.

Dual Function Burner: Expand your cooking capabilities with a single Dual Function Burner that allows you to simmer at 800 BTU or perfectly sear at 20,000 BTU.

Convection Gas Oven: Elevate your culinary endeavors with standard bake, broil, and convection bake modes with a maximum BTU output of 22,000.

Large Oven Capacity: Large oven capacity of 4.2 cu. ft. fits pans up to 20 in. wide for maximum space and convenience.

StayPut Oven Door Hinges: Designed to support the full weight of the oven door, offering additional convenience and safety.

Premium Oven Insulation: A 3-layered glass oven door with a large viewing window and aluminum mesh seal offers superior heat retention and consistent temperatures.

Smooth Glide Ball-Bearing Oven Racks: 2 durable ball bearing oven racks provide extra convenience and ease when working with larger dishes.

LP Conversion Kit: Comes equipped with an LP conversion kit to convert from natural gas to liquid propane (must be done by a professional), offering versatility with your cooking preference.

OVEN FEATURES

Interior Dimensions	24 7/8" W x 17 3/4" D x 16" H
Self-Clean	No
Oven Lighting	(2) Halogen
Oven Features	Bake, Broil, Convection Bake
Convection Fan	Yes
Number of Racks	2
Child Lock	No

OVEN BTU

Broil BTU Output	10,000 BTU
Bake BTU Output	22,000 BTU

ELECTRICAL REQUIREMENTS

120 V / 60 Hz / 15 A Dedicated Circuit

LIMITED WARRANTY

Manufacturing Warranty: 1-year parts and labor.

Italian Burners and Spark Tips: Limited Lifetime Warranty.

Limited Lifetime includes: parts replacements for burners, burner caps, and parts and labor for the spark tip if parts prove to be defective in materials or workmanship.

**Appliance protection plans sold separately, contact for more information.*

GENERAL PROPERTIES

SKUs	SGR30, SGRS-30, SGRB-30, SGRBS-30
Base Finishes	Stainless Steel, Black Stainless Steel, Satin Stainless Steel, Black Satin Stainless Steel
Fuel Type	Gas (Propane or Natural Gas)
Burners	4
Mount Type	Free Standing
Timer	No
Material	430 Grade Stainless Steel
Grates	Modern
Certification	ETL Certified

DIMENSIONS AND WEIGHT

Product Dimensions	30" W x 27 3/4" D x 36" H
Cutout Dimensions	30 1/4" W x 24 3/4" D x 36" H
Product Weight	218 lb (98.8 kg)

COOKTOP FEATURES

Burners	(3) Aluminum Burners and (1) Brass Burner
Cooktop	Porcelain With Electronic Spark Ignition For All Burners

COOKTOP BTU (Electronic Ignition and Auto Re-ignition)

Back Left (Semi-Rapid)	9,000 BTU
Front Left (Rapid)	15,000 BTU
Back Right (Semi-Rapid)	9,000 BTU
Front Right (Dual)	20,000 BTU

Not the right fit? [Click here](#) to view our range collections.

PARAMOUNT RANGE SERIES (SGR)

30 in. 4.2 cu. ft. Range with 4 Burner Cooktop and Convection Gas Oven

ZLINE
ATTAINABLE LUXURY®

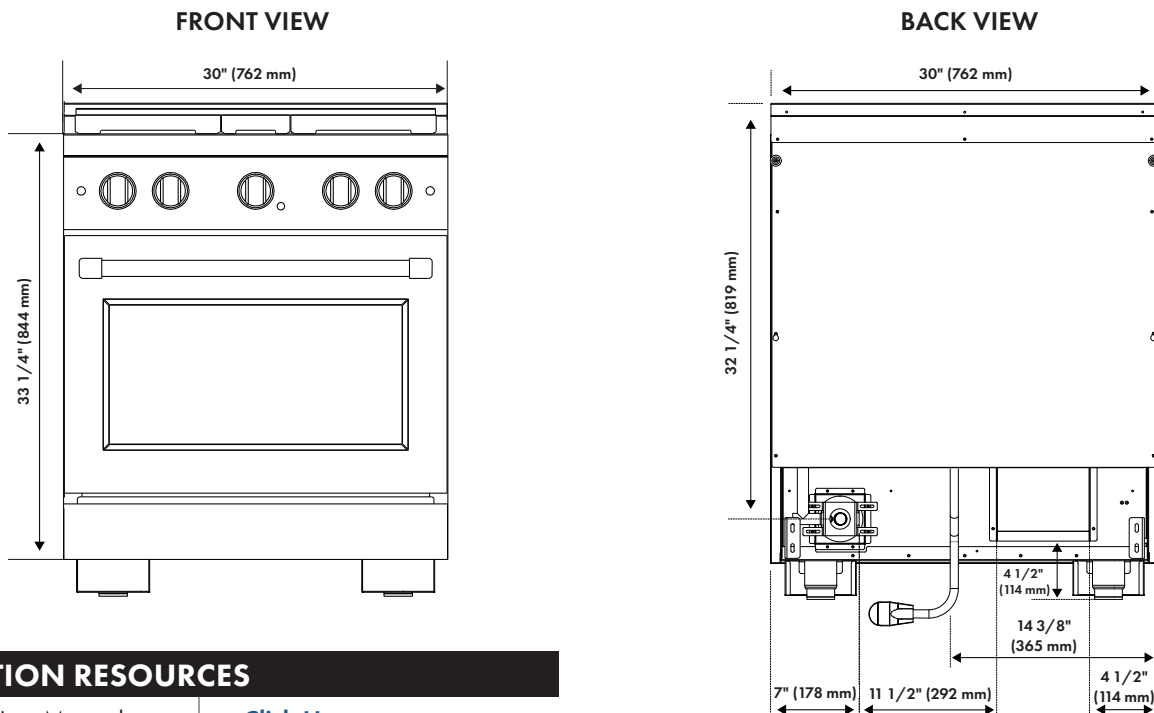

INSTALLATION RESOURCES

Installation / User Manual

[Click Here](#)

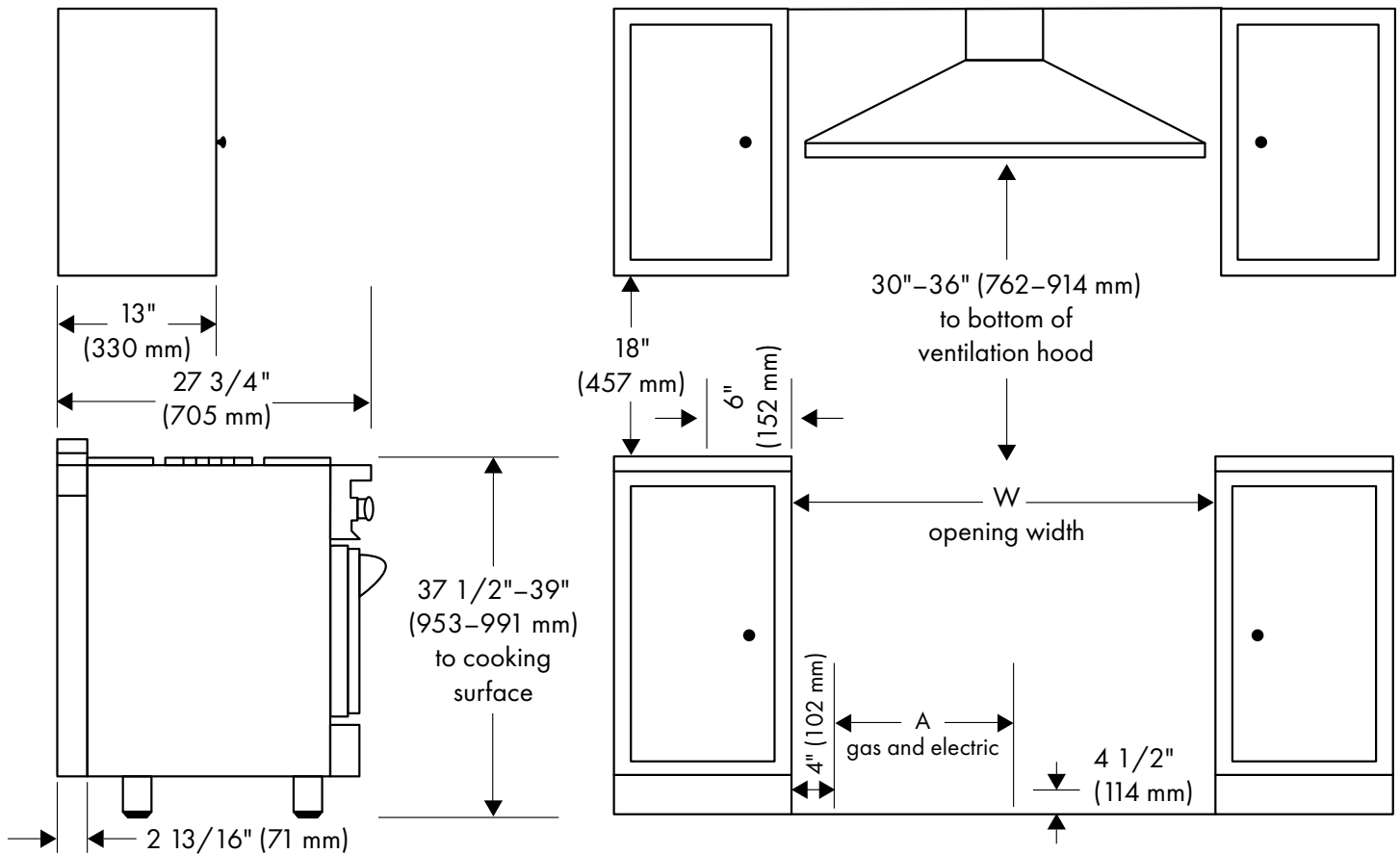

Range Series	W (opening width)	A (available space - gas)
SGR30	30 1/4" (768 mm)	15" (381 mm)

AUTOGRAPH EDITION

Andrew Ferro

Satin Stainless Steel With
Matte Black Accents



SATIN STAINLESS STEEL

Polished Gold	SGRSZ-30-G
Champagne Bronze	SGRSZ-30-CB
Matte Black	SGRSZ-30-MB

Stainless Steel With
Champagne Bronze Accents



STAINLESS STEEL

Polished Gold	SGRZ-30-G
Champagne Bronze	SGRZ-30-CB
Matte Black	SGRZ-30-MB

Black Satin Stainless Steel With
Champagne Bronze Accents



BLACK SATIN STAINLESS STEEL

Polished Gold	SGRBSZ-30-G
Champagne Bronze	SGRBSZ-30-CB

Black Stainless Steel With
Champagne Bronze Accents



BLACK STAINLESS STEEL

Polished Gold	SGRBZ-30-G
Champagne Bronze	SGRBZ-30-CB

AUTOGRAPH EDITION + COLORED DOOR

Stainless Steel White Matte Door
With Champagne Bronze Accents



STAINLESS STEEL WITH WHITE MATTE DOOR

Polished Gold	SGRZ-WM-30-G
Champagne Bronze	SGRZ-WM-30-CB
Matte Black	SGRZ-WM-30-MB

AUTOGRAPH ACCENT COLORS

Autograph Edition Includes:
Brass Burners, Autograph Edition Knobs, Knob Rings, Handle and 2 Feet Covers.



BASE FINISHES

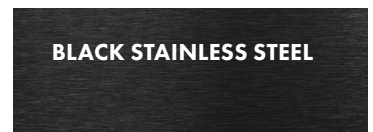

AUTOGRAPH EDITION

Andrew Ferro

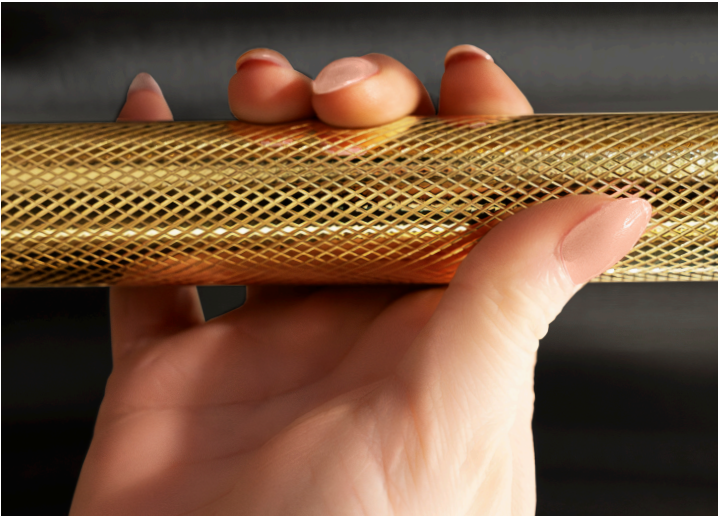

Helix Handles:

Not offered as a range bundle SKU. Handle must be purchased separately.



POLISHED GOLD



CHAMPAGNE BRONZE

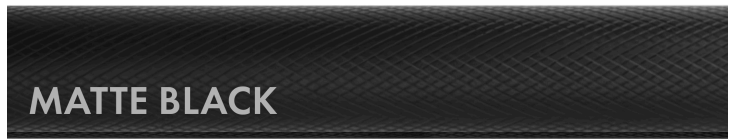

MATTE BLACK

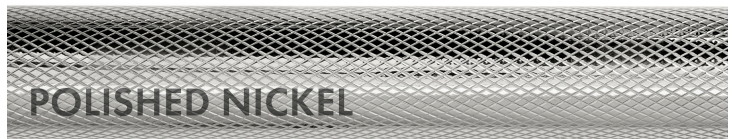

POLISHED NICKEL

STANDARD HELIX HANDLE SET (SET OF 1)

Black Stainless Steel Helix Handle	SGZ-054B-K-BS
Stainless Steel Helix Handle	SGZ-054B-K-ST

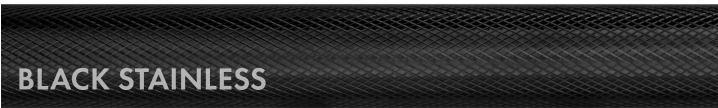

BLACK STAINLESS

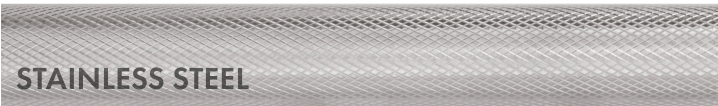

STAINLESS STEEL

AUTOGRAPH HELIX HANDLE (SET OF 1)

Polished Gold Helix Handle	SGZ-054B-K-G
Champagne Bronze Helix Handle	SGZ-054B-K-CB
Matte Black Helix Handle	SGZ-054B-K-MB
Polished Nickel Helix Handle	SGZ-054B-K-PN

RANGE + COLORED DOOR

Stainless Steel
With White Matte Doors



STAINLESS STEEL

Black Matte Door	SGR-BLM-30
White Matte Door	SGR-WM-30

Satin Stainless Steel
With Black Matte Doors



SATIN STAINLESS STEEL

Black Matte Door	SGRS-BLM-30
White Matte Door	SGRS-WM-30

BRASS BURNER BUNDLE

Stainless Steel
With Brass Burners



STAINLESS STEEL

Stainless Steel	SGR-BR-30
Black Stainless Steel	SGRB-BR-30

Set of 4 Italian
Brass Burners



SATIN STAINLESS STEEL

Satin Stainless Steel	SGRS-BR-30
Black Stain Stainless Steel	SGRBS-BR-30

* Assembly Required: Colored doors will ship separately

* Assembly Required: Brass burners will ship separately

ZLINE KITCHEN ACCESSORIES

Range + Kitchen Compatible Accessories

ZLINE
ATTAINABLE LUXURY®

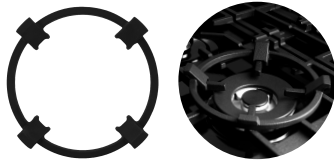

Cooktop Wok Ring | RA-005A



Cleaner/Polish | STCLT-8



Reversible Cast Iron Griddle | SR-GRNS



German Steel
15 Piece Knife Set | KSETT-GS-15



German Steel
3 Piece Knife Set | KSETT-GS-3



Japanese Damascus
3 Piece Knife Set | KSETT-JD-3



10-Piece
Stainless Steel
Cookware Set | CWSETL-ST-10



10-Piece Stainless
Steel and Ceramic
Cookware Set | CWSETL-NS-10



5-Piece Black
Matte Enameled
Cast Iron Set | CWSETS-BLM-5



5-Piece White
Matte Enameled
Cast Iron Set | CWSETS-WM-5

CONTACT INFORMATION



PHONE

Customer Service
1-614-777-5004

Dealer Assistance
1-833-597-2461



HOURS OF OPERATION

Customer Service
Monday–Friday 6:00am–4:30pm CST

Dealer Assistance
Monday–Friday 7:00am–4:00pm CST



EMAIL

Customer Service
contact@zlinekitchen.com

Dealer Assistance
dealer@zlinekitchen.com