

# Balón Series

Borderless, or Minimally Bordered Flexible Screen System

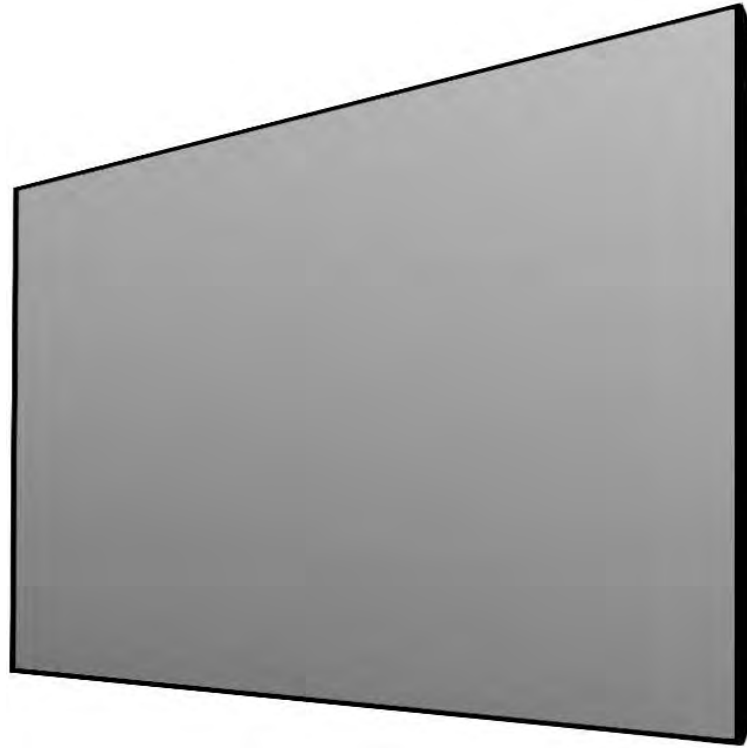

**Stewart**  
F I L M S C R E E N

The Reference for Stunning™

**Printed in the USA. ©2022 Stewart Filmscreen Corporation**

Stewart Filmscreen reserves the right to make changes to the product specified in this document.

Sizes and specifications are subject to change without notice at Stewart's discretion. From time to time, this document is updated. Current versions of this documentation are posted on the Stewart Filmscreen website at:

[www.StewartFilmscreen.com](http://www.StewartFilmscreen.com)

Revision 2.1.01

Date: 04/12/2022

# Balón Series

## OWNER'S MANUAL

### Contents

To the Owner	4
About the Balón Series	5
Installation Preparation	6
Frame Assembly	7
Flush Mount Bracket System	9
Telescoping Mount Bracket System	11
LED Kit Installation Guide	14
LED diagram	17
Attaching the Screen to the Frame (Vinyl & Woven Materials)	18
Attaching the Screen to the Frame (BlackHawk UST Material)	20
Attaching the Border Trim (Balón Edge Only)	23
Installation Troubleshooting	24
Caring for and Cleaning the Screen	25
One (1) Year Limited Warranty	26

## TO THE OWNER

---

Congratulations on purchasing the finest optical viewing screen in the world.

Your handcrafted, Balón Series projection screen has been carefully inspected to ensure you will have an optimal viewing experience that will last many years. Please take a moment to review this manual. It will guide you through the installation and the operation of your screen, and will also provide you with detailed instructions on how to care for your screen's viewing surface.

From all of us at Stewart Filmscreen, we would like to thank you for choosing the Balón Series. Should you have any questions, please don't hesitate to contact our customer service department at 1 (310) 784-5300, or toll free at 1 (800) 762-4999. We're here to help.



Mary Stewart  
CEO and Owner



Frank Gomez  
Fixed Frame Masking Specialist

## **ABOUT THE BALÓN SERIES**

---

This is the most progressive wraparound frame available on the market. With optional LED lighting capability, great scalability and offered with Stewart's most in-demand screen materials, the new Balón Series checks all the boxes – all with keeping the image plane within one and one-half inches off the wall's surface. Choose Balón Edge with a minimal, half-inch black over scan border, giving on-screen content perceived contrast and a crisp edge. Or choose Balón Borderless where there is no black border, allowing the image on the screen to appear to float in the room.

### **USING THIS MANUAL FOR INSTALLATION**

Before proceeding with the installation, please take a few moments to thoroughly read and understand these instructions.

This owner's manual covers the Balón Series family of products. Each headline to the sections will make it clear which Balón specification the respective steps refer to.

# INSTALLATION PREPARATION

---

Before proceeding with the installation of the screen, take time to thoroughly read and understand these installation instructions. **Failure to comply with the instructions contained in this manual may result in voiding your warranty.**

1. Make sure there is a clean surface on which to unroll the screen and assemble the frame.
2. Check the size and weight of the screen to be installed so that you can plan for the number of people required for installation. Specifications regarding the individual screen dimensions, weight, etc. are provided by the factory when the screen is ordered.
3. You will need at least two people to mount the screen, depending on the size and weight of the unit. More are needed for larger, heavier screens.

## What's Inside the Box?

Inside the box you will find everything needed to get started on enjoying your Balón screen.

- ▶ Screen material placed in a tube with packing material for protection
- ▶ Disassembled frame and all necessary hardware to re-assemble frame
- ▶ Hanging bar and mounting hardware
- ▶ LED lighting kit, if ordered
- ▶ White cloth gloves (for UST Material only)
- ▶ Quick Start Guide

## You Will Need:

- ▶ A level
- ▶ A drill
- ▶ A drop cloth
- ▶ Tools for tightening fasteners
- ▶ Lint-free, clean cloth gloves for handling the screen
- ▶ Ladders for the personnel supporting the screen during the mounting process
- ▶ Fasteners appropriate for the surface on which the screen is being mounted

**Note:** Bolts and other fasteners for the screen are standard gauge and are sized for use in the USA. For this reason, the sizes are expressed in inches rather than metric measurements.

# FRAME ASSEMBLY

---

## Unpacking

Use a drop cloth to protect all surrounding surfaces and be sure to unpack carefully in a clean area. Use special care when handling the screen material so that it does not become soiled or damaged. If you plan to repack your screen and hardware for transportation to another location, you may wish to photograph or make a note regarding how it was packed. Keep the original packing material for future use, if desired.

### **⚠ CAUTION**

Do not stand on the screen tube or store it on its end. This will cause screen damage. If you are not installing the screen immediately, make sure it remains horizontal during storage.

## Frame Assembly Instructions

1. Connect the frame members by matching numbered dots on the ends of the members (see Figure 1).

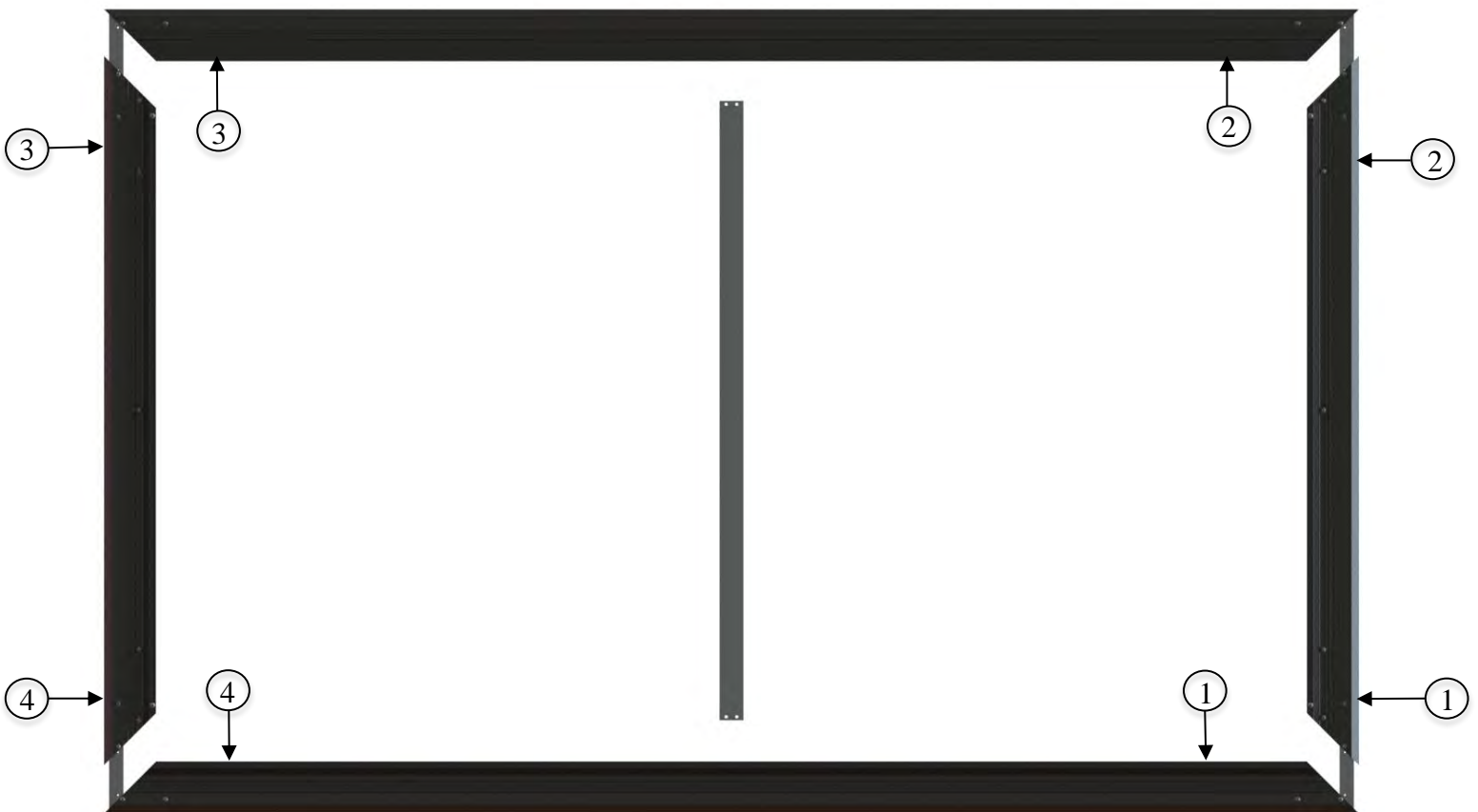

Figure 1: Frame assembly rear view

## FRAME ASSEMBLY (CONT.)

---

2. Secure the frame members with the supplied 1/4" -20 x 3/8" bottom socket head bolts (see Figure 2).



**Figure 2: Fastener locations**

3. Some of the larger Balón screen frames will require a back brace (included) to keep the integrity of the frame intact. The brace will also attach to the frame with 1/4" -20 x 3/8" bolts. Make sure to install any provided back braces. Once all corners of the frame are secure, you are now ready to temporarily hang the frame. **Please note that the screen material and optional LED lighting kit, should not be attached at this point.**



# FLUSH MOUNT BRACKET SYSTEM

---

Note: Professional mounting techniques should be used. Stewart Filmscreen cannot be liable for substandard or faulty installations. Failure to comply with the instructions and guidance contained in this manual may result in voiding your warranty.

To accurately position the Balón Series frame, you will need to mount the Flush Mount hanging bar and temporarily hang the frame prior to attaching the screen material.

**Note:** The screen material should not be attached to the frame at this point.

1. Identify the location of wall studs where you can securely mount the Flush Mount hanging bar.
2. Fasten and secure the magnet mount into the rail of the frame (See figure 3).

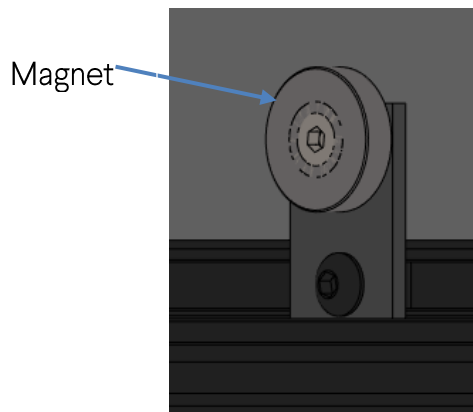

Figure 3: Magnet Mount Assembly

3. Use a level to accurately position the Flush Mount hanging bar on the wall.
4. Drill holes through the bar into the studs.
5. Use the provided 2" screws or other appropriate fasteners to secure the Flush Mount hanging bar to the wall studs (see Figure 4).

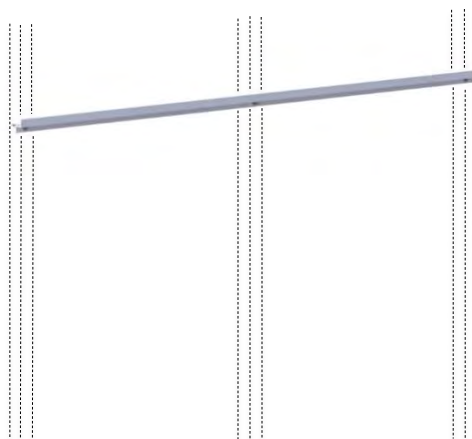

Figure 4: Flush Mount hanging bar

## **FLUSH MOUNT BRACKET SYSTEM (CONT.)**

---

**Note: A minimum of three (3) screws are recommended to safely secure the frame.**

1. Check to make sure the bar is level.
2. Without the screen attached, hang the assembled frame onto the Flush Mount hanging bar to ensure that it is correctly mounted (see Figure 5).



**Figure 5: Cross section of frame mounted on Flush Mount hanging bar**

3. Mark the wall where you will mount the steel pucks to the studs that will align with the magnets that are fastened on the frame.
4. Remove the frame and follow the steps for attaching the screen to the frame.\*  
(For vinyl & woven snap material, refer to page 18. For BlackHawk UST lace and grommet material, refer to page 20).

**\*Note:** If an LED kit was purchased, please follow the install guide on the page 14 before proceeding to screen attachment.

## **TELESCOPING (STAND OFF) MOUNT BRACKET SYSTEM**

Note: Professional mounting techniques should be used. Stewart Filmscreen cannot be liable for substandard or faulty installations. Failure to comply with the instructions and guidance contained in this manual may result in voiding your warranty.

To accurately position the Balón Series frame, you will need to mount the Telescoping Mount and temporarily hang the frame prior to attaching the screen material.

**Note:** The screen material should not be attached to the frame at this point.

5. Attach the provided telescoping mounts by unscrewing and reinstalling the attached cap screws in the mounting rail on the frame with the telescoping mount (see Figure 6).



**Figure 6: Telescoping Mount to frame attachment**

6. Identify the location of wall studs where you can securely mount the Telescoping Mount wall brackets.
7. Use a level to accurately position the Telescoping Mounts on the wall.
8. Drill holes through the wall brackets into the studs.

## TELESCOPING MOUNT BRACKET SYSTEM (CONT.)

---

9. Use the provided 2" screws or other appropriate fasteners to secure the Telescoping Mounts to the wall studs (see Figure 7).

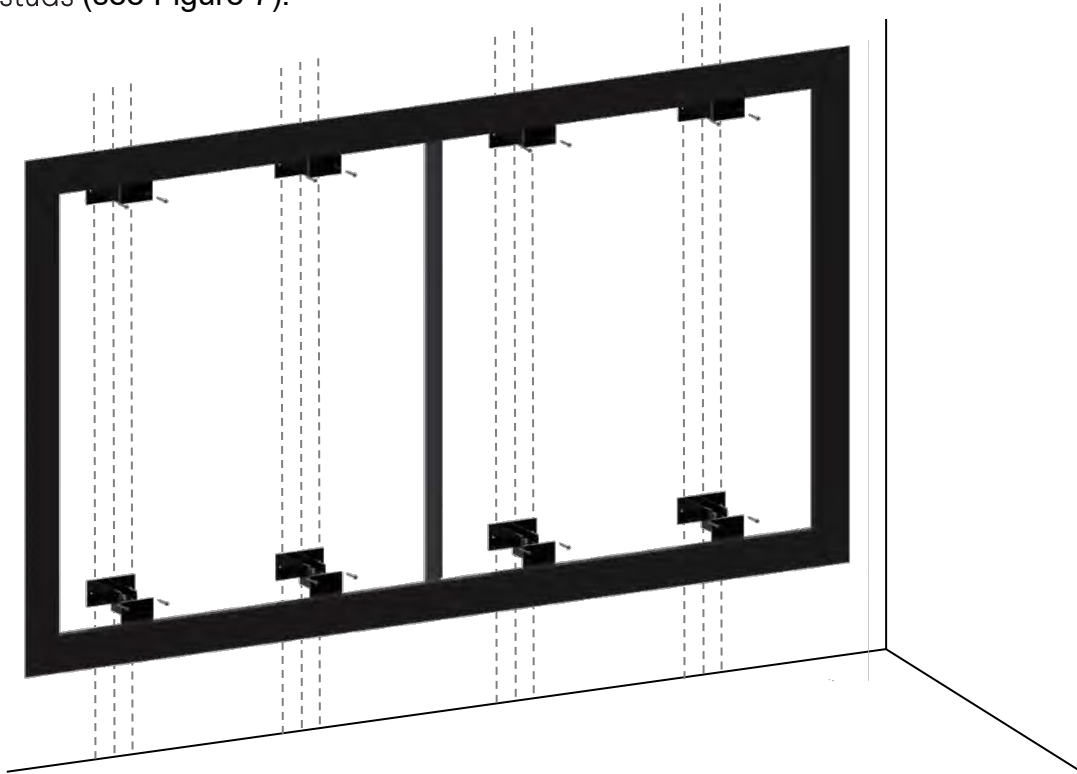

Figure 7: Mounting the frame with the Telescoping Mounts

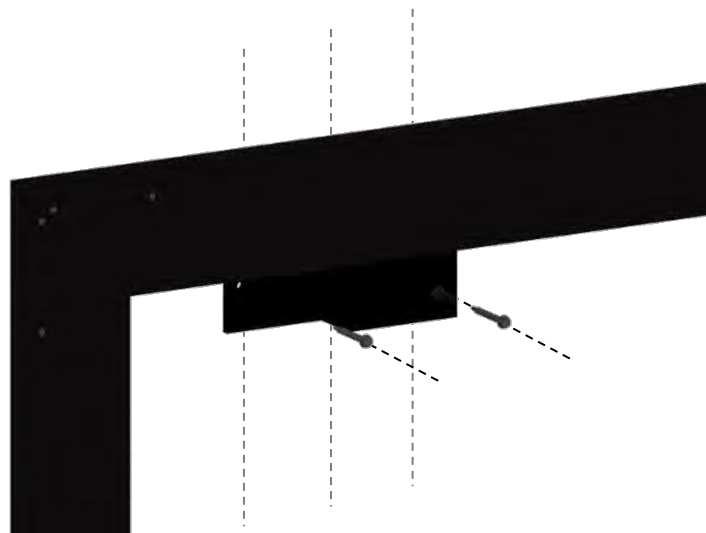

Figure 8: Mounting Detail

## TELESCOPING MOUNT BRACKET SYSTEM (CONT.)

---

6. After the frame has been mounted, remove the frame by uninstalling the telescoping mount wall bracket that is attached to the frame bracket (see Figure 9).



**Figure 9: Rear view of frame uninstalled from Telescoping Mount wall bracket.**

7. Remove the frame and follow the steps for attaching the screen to the frame.\*  
(For vinyl & woven snap material, refer to page 18. For BlackHawk UST lace and grommet material, refer to page 20).

**\*Note:** If a LED kit was purchased, please follow the install guide on the next page before proceeding to screen attachment.

# LED KIT INSTALLATION GUIDE

---

Use the following steps to connect the LED kit to the Balón Series.

**Note: This step should always precede screen material attachment.**

1. Insert the control box to the control box case provided with your LED kit. The control box power port should be aligned with the hole of the case (see figure 10)

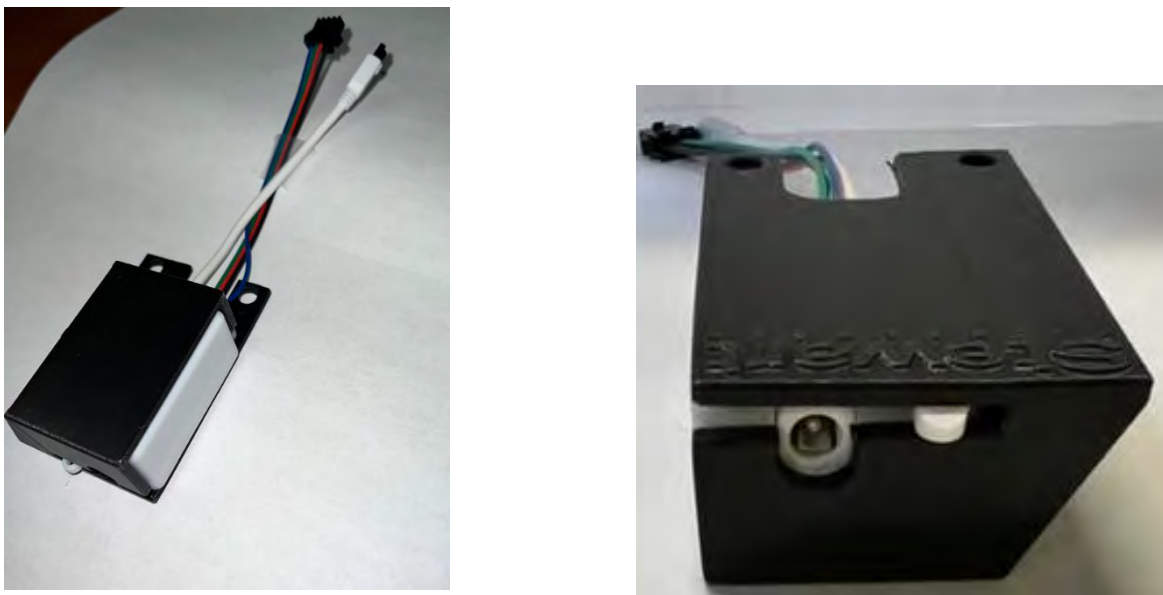

Figure 10: Insert Control Box to Control Box Case

2. Using the pre-installed nut to attach the control box to the bottom right corner of the frame. Make sure that the wires go through the notch in the frame and the white wire it's clipped on the wire holder (See Figure 11).

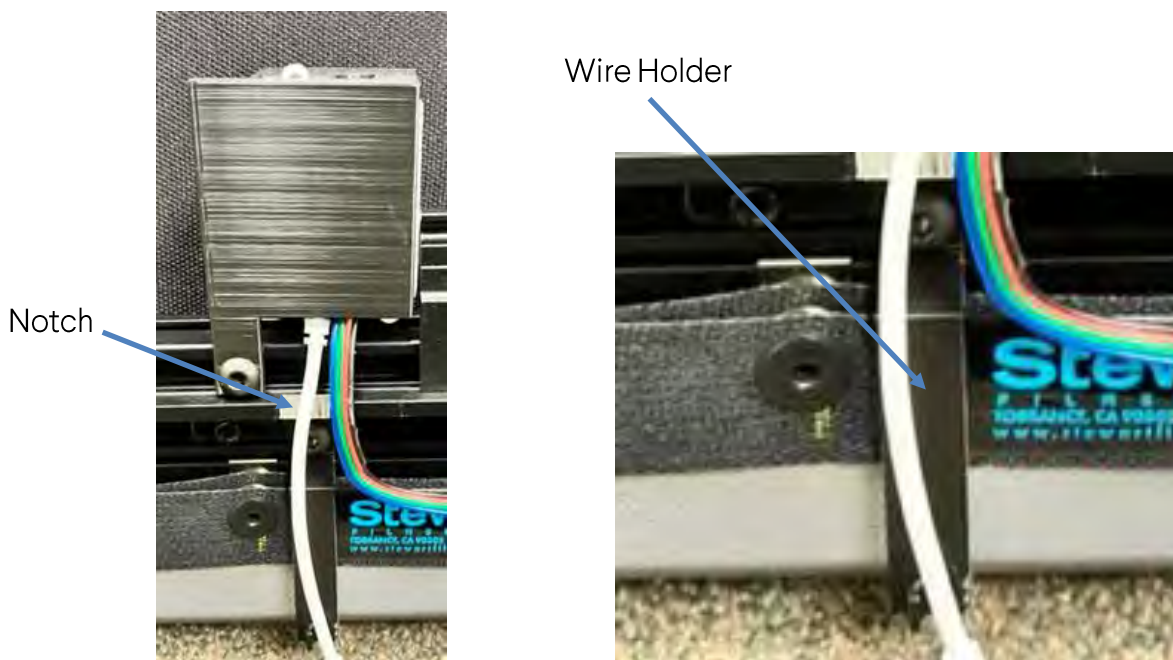

Figure 11: Control Box Attachment and wire holder

# LED KIT INSTALLATION GUIDE (CONT.)

- 3. Position the LED along the rail. Make sure the adhesive side on the LED strip is positioned on the rail (Figure 12), and about 1/4 inches from the edge (see Figure 13).

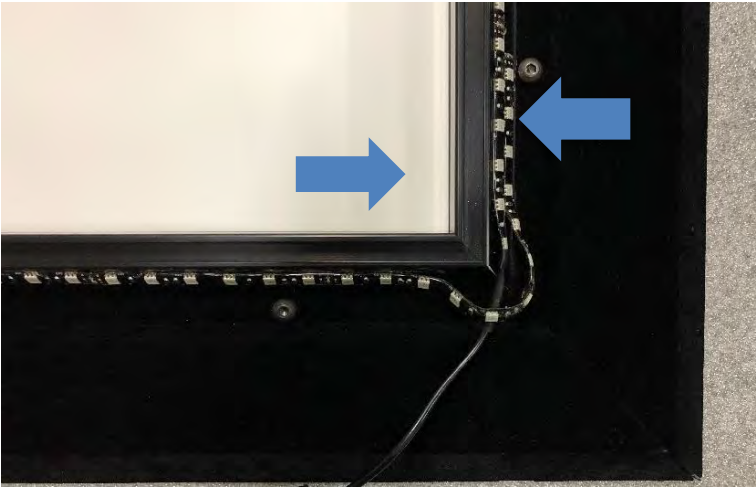

Figure 12: Place the LED on the rail

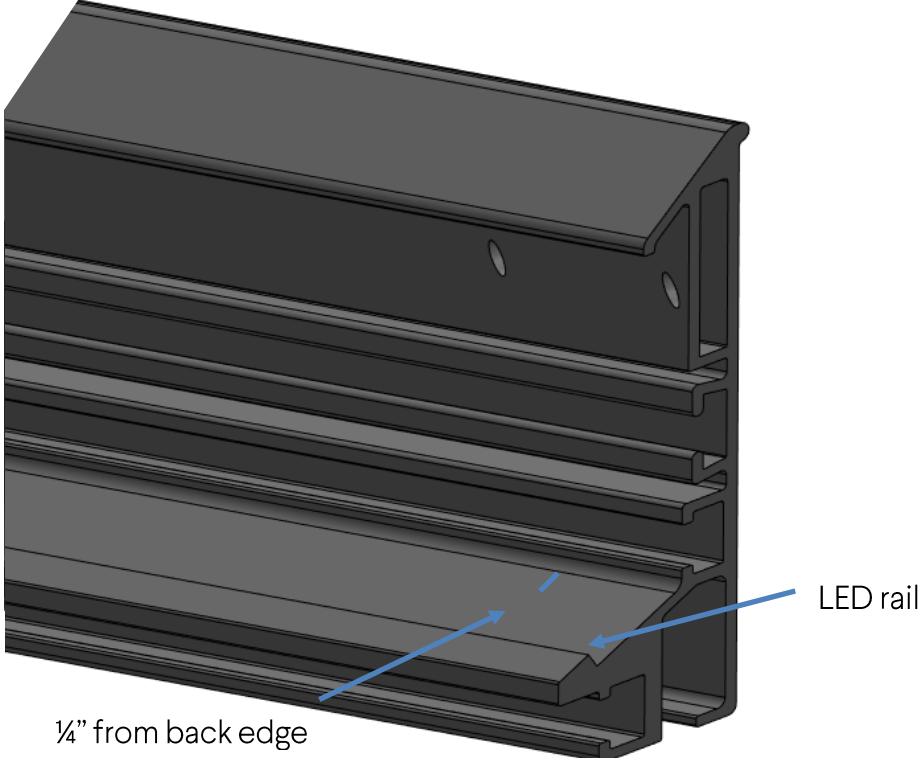
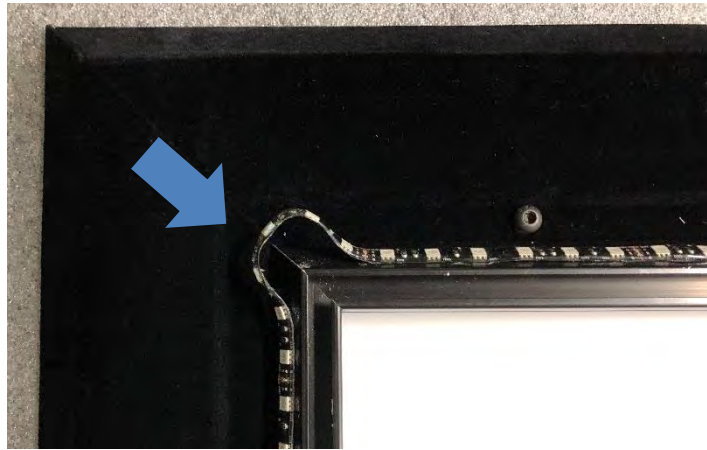

Figure 13: Cross section of Balón frame indicating LED rail

## LED KIT INSTALLATION GUIDE (CONT.)

---

4. Once you reach the corner/turn on the frame, make a wide loop with the LED strip so that at least 4-5 LED diodes are hanging in the corner to even out the light field coverage (see Figure 14).



**Figure 14: Corner loop for LED coverage**

5. Repeat on all four sides, as well as the corners, until you reach the initial starting point.
6. Test out the LED kit with the provided power source before screen material attachment to ensure the LEDs are working as intended.



# LED KIT DIAGRAM

The Stewart Filmscreen 4 Amp 12V dc power supply is used to provide power to all our LED lighting kits with 1-2 16 foot LED rolls. This ultra-high capacity power supply is perfect for small to large-scale applications requiring multiple LED lighting hardware, by providing a single power source instead of multiple low capacity DC power supplies. Direct plug and play 12V dc output connection available for various connectivity configurations. Please read all information in the instructions for proper wiring and connectivity.

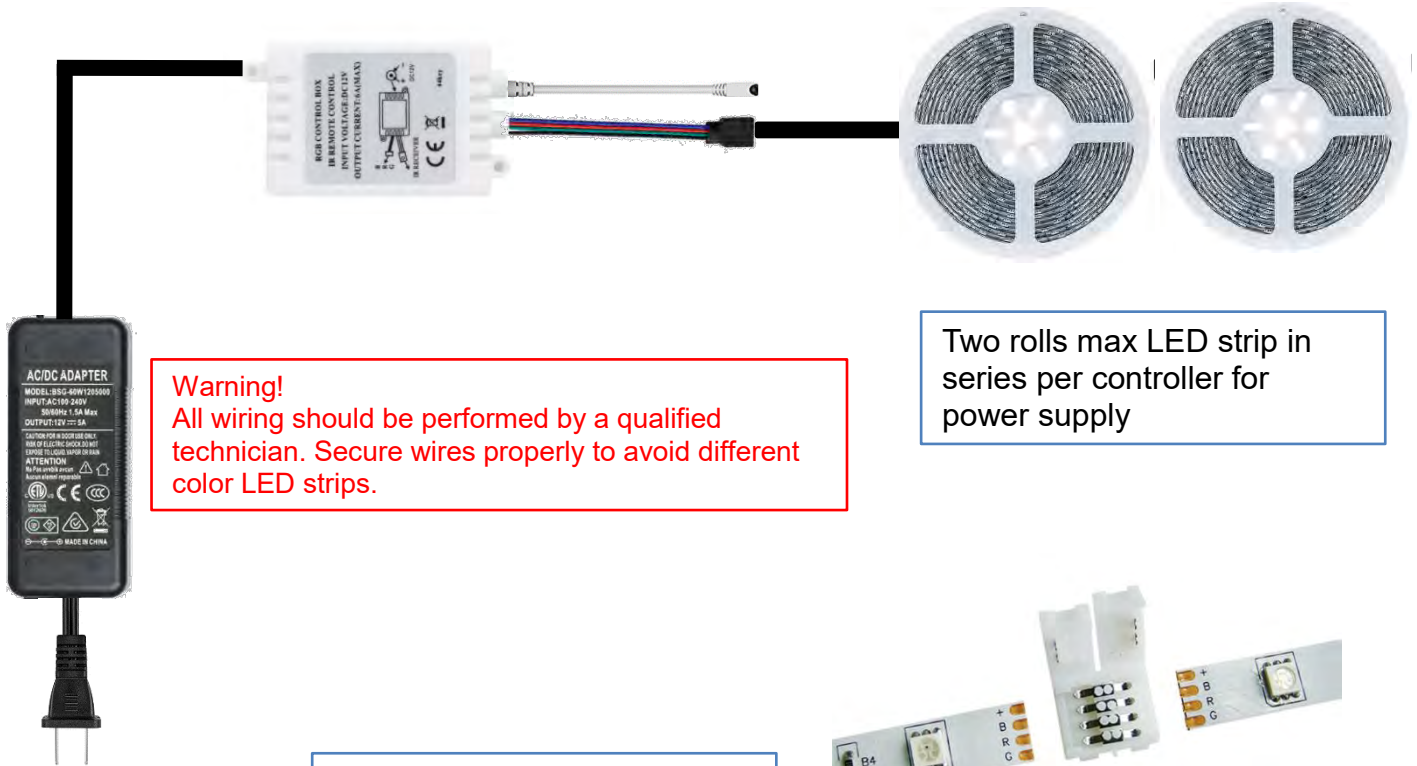

**Warning!**  
All wiring should be performed by a qualified technician. Secure wires properly to avoid different color LED strips.

Two rolls max LED strip in series per controller for power supply

**Please note:**  
This power supply should be enclosed in a proper metal enclosure and not exposed to the elements. Never mount in an open area or in an attic space.

For two rolls, use the provided clip to attach the LED strips in series



If LED strip is too long, it might be cut to length only along indicated cut line

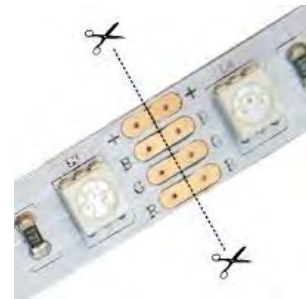

## **ATTACHING THE SCREEN TO THE FRAME (VINYL & WOVEN)**

DO NOT perform this step until instructed to do so in the mounting section. Remember that the optional LED light kit, if ordered, should already be installed prior to putting on the screen material.

### **⚠ CAUTION**

- ▶ Be careful not to touch or scratch the viewing surface
- ▶ Do not use any tools to fasten the screen to the frame
- ▶ Do not fold or crease the screen
- ▶ Wear lint-free gloves

### **Unpacking and Unrolling the Screen**

The viewing side of the projection screen is rolled to the inside to protect the optical coating. The screen is rolled lengthwise.

1. Remove the screen from the cardboard shipping tube.
2. On a clean surface, unroll the screen viewing side down.
3. Leave the protective packing material under the screen material to protect the screen. Make sure that the top and bottom of both the screen material and the frame are both in the same direction (see Figure 15).



**Figure 15: Unrolling the screen material, viewing side down**

## **ATTACHING THE SCREEN TO THE FRAME (CONT.)**

---

4. Lay the frame on top of the screen, mounting side up. Starting with the snaps on each of the corners, lift the screen and snap the screen onto each snap. Then, snap the rest of the screen starting with the snaps in the middle of the frame and move out towards the corners. Be careful not to jerk, wrinkle, or crease the screen material.

**Note: For vinyl and woven screen materials: If there are any wrinkles or puckers in the screen, adjust the snaps on the frame from side to side. Lay the frame viewing side down on a clean surface. A movement of 1/16" to 1/8" (1.6mm to 3.2mm) is usually sufficient to eliminate any puckers.**

5. If your screen material has tension tabs in the corners of the frame (vinyl materials only), gently fold each tension tab over to help close any gaps created while wrapping (see Figure 16).



**Figure 16: Screen corner tension tab**

## **ATTACHING THE SCREEN TO THE FRAME (BLACKHAWK UST MATERIAL)**

### **⚠ CAUTION**

- ▶ The BlackHawk UST screen material is unlike any other screen material. **Special handling is required. Please read all directions before attempting to install.**
- ▶ A minimum of two people (preferably more) are required to install the BlackHawk UST screen material.
- ▶ White gloves (included) are needed to protect the screen surface. **Improper handling will cause permanent damage to the screen.**
- ▶ Do not fold or crease the screen.

1. Roll the screen out onto a drop cloth on the floor with the viewing side facing down (see Figure 16).
  - a. The BlackHawk UST comes pre-rolled with a foam liner on the viewing side.
    - For added protection, lay a plastic liner or clean sheet on the floor.
    - Simply roll the screen out on the clean surface, and the liner will shield the viewing surface from contact with the floor.
  - b. White gloves (provided) should ALWAYS be worn when handling the screen material to prevent damage to screen surface.

Note: The screen is labelled “Top” and “Bottom.” These MUST match the “Top” and “Bottom” labels on the frame for proper viewing.



Figure 16: Roll screen out, viewing side down

## **ATTACHING THE SCREEN TO THE FRAME (BLACKHAWK UST)** **(CONT.)**

**IMPORTANT:** For best results in maintaining screen alignment on the frame, have at least two or more people work on opposite edges of the screen at the same time.

2. Carefully lay the frame on the screen, with the lacing cord facing up.
  - a. Once again, ensure the “Top” and “Bottom” labels on the screen align with the “Top” and “Bottom” labels on the frame.
  - b. Align all four corners of the screen with the corners of the frame (see Figure 17).



**Figure 17: Align corners of screen with corners of frame**

3. How to lace the screen to the frame.
  - a. For this step, Stewart recommends at least two people (preferably more) working on opposite sides of the screen to assist in maintaining proper alignment of the screen onto the frame.
  - b. Start by connecting each red S-hook with each of the red grommets, located at the center of each frame section.

**IMPORTANT:** For best results, connect either all four red hooks at once. Or, connect two red hooks at a time, located on opposite sides of the frame.

- c. Once all four red hooks have been connected, double check the corner alignment and adjust if necessary.
  - d. Lace the rest of the screen by working outward from the center red hooks towards each corner. Remember, hooks should be connected simultaneously on both sides of the center hook to assure that tension is accumulated on the screen from the center of the screen and outward.



## ATTACHING THE SCREEN TO THE FRAME (BLACKHAWK UST) (CONT.)

e. Repeat this process until the first four hooks on either side of each red hook have been laced.

**IMPORTANT:** By this point, you should have enough uniform tension on the screen to lace the remaining hooks without causing misalignment of the screen and frame.

f. The final hooks at each corner should be connected to the screen by **crossing the lacings**. The final S-hook on the vertical frame connects to the final grommet on the horizontal screen edge and vice versa (see Figure 18).

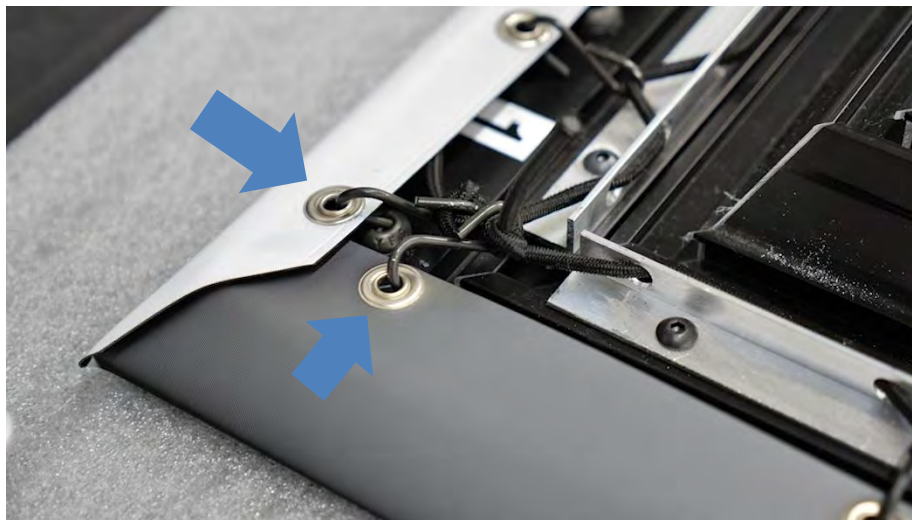

Figure 18: Cross lace corner hooks

4. Attach the border trim to the screen assembly. See following page.

## **ATTACHING THE BORDER TRIM (BALÓN EDGE ONLY)**

---

**Use the following steps to connect the border trim to the Balón Edge.**

1. Unscrew the preinstalled cap screws on the frame.
2. Place front edge of the border onto the screen material.
3. Make sure the border trim is centered along the side on the screen.
4. Keeping your fingers off of the screen material, lay trim piece into place.
5. Secure the trim in place using screws previously removed during Step 1 (see Figure 19).

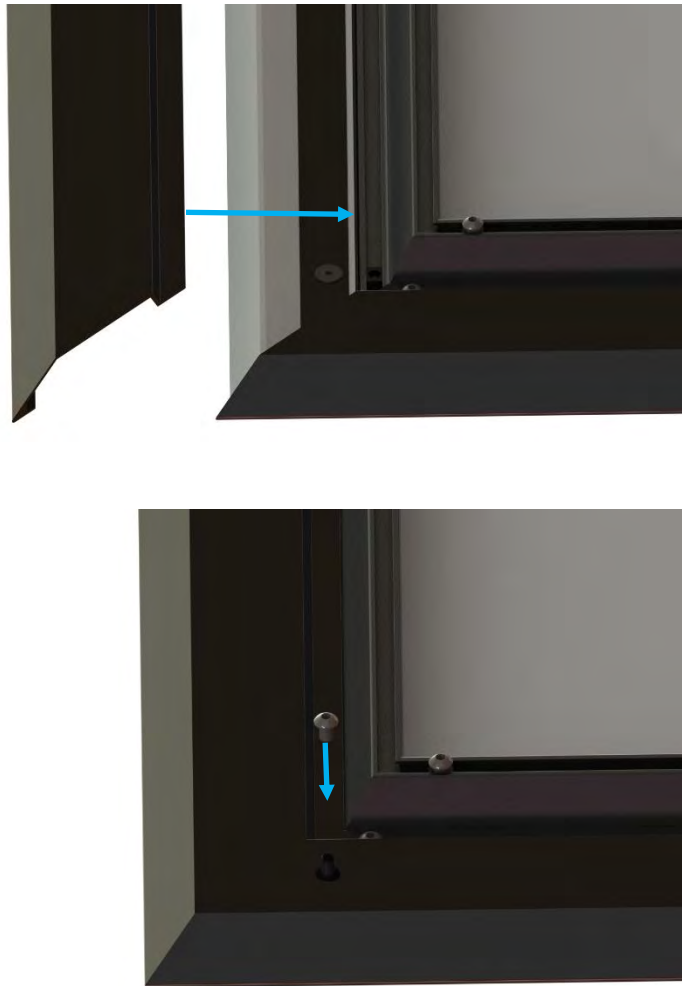

**Figure 19: Border trim installed onto frame**

## INSTALLATION TROUBLE SHOOTING

---

(Vinyl) screen material doesn't fit or it seems too small (see Figure 16).

1. Make sure the screen material has been correctly installed onto the screen frame. Refer to pages 18-19.
2. If screen was installed starting with the middle snaps, the whole screen must be removed/unsnapped and reinstalled starting with the snaps on the corners of the screen.

**Note:** The snaps on the frame may have moved from the first installation. Make sure corners are in place and snapped first. To determine final position of snaps on rail, start with the middle snap on each side.

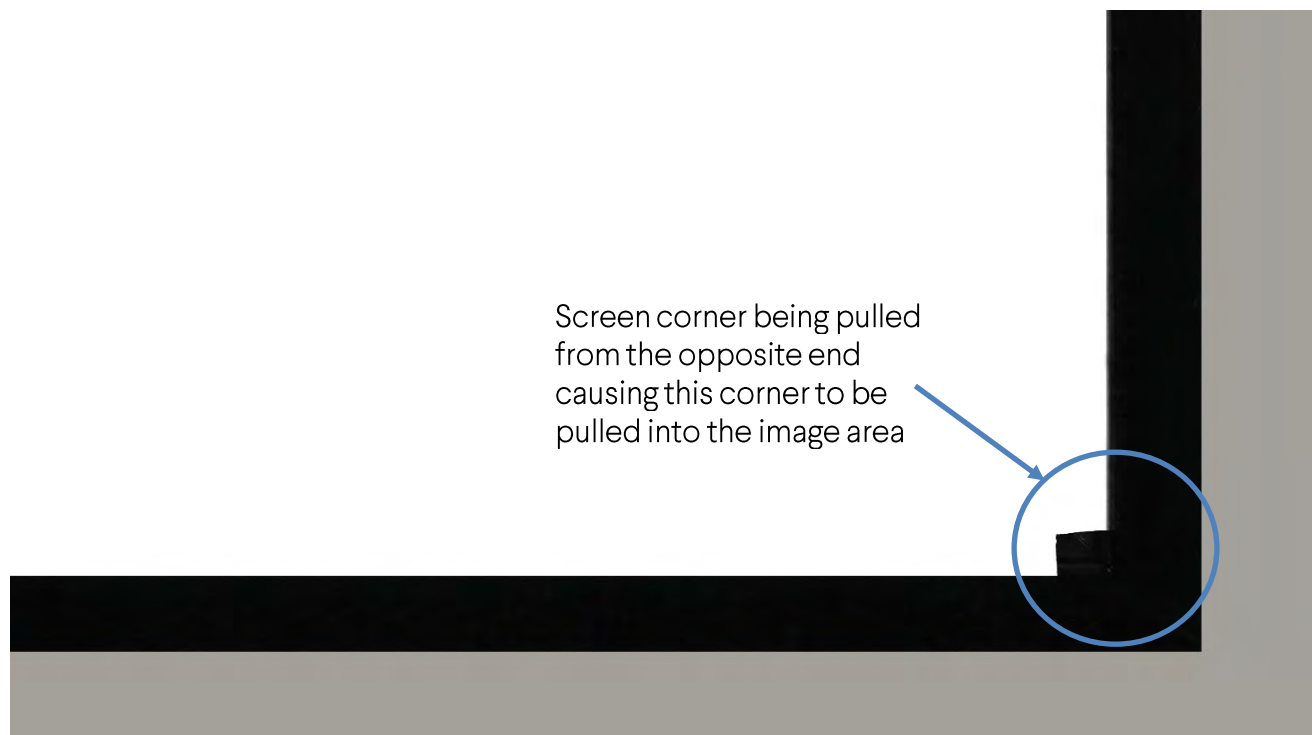

**Figure 21: Example of overstretched screen material**



# CARING FOR AND CLEANING THE SCREEN

---

## General Maintenance

With reasonable care, you may expect many years of dependable use of your Stewart projection screen.

### FOR VINYL SCREEN MATERIALS ONLY

The surface of your screen is delicate, so we encourage you to keep your screen clean. Special attention to these instructions should be followed when cleaning.

- ▶ Avoid getting any foreign objects on the screen, as cleaning may prove to be difficult. It may not be possible to remove scratches, paint, ink, etc.
- ▶ A draftsman-style brush may be used to lightly whisk away any loose dirt or dust particles. (This type of brush is usually available at office supply store.)
- ▶ For tougher spots, you can make a cleaning solution using a water-based detergent and warm water. To make the solution, mix one part Simple Green, 409, or other water based industrial cleaner with three parts warm water. Moisten a clean cotton cloth or Q-Tip with this solution, moisten the stained area, and gently lift off the stain. Never use an aggressive scrubbing action as you could damage the screen surface by removing the optical coating. Remoisten the area with clean water and dab dry with a clean sponge or cotton cloth. Any residual watermarks will evaporate on their own in a few minutes.
- ▶ Contact tech support at Stewart Filmscreen if you have questions about removing difficult spots.

### CAUTION

- ▶ Do not use any other cleaning materials on the screen.
- ▶ Do not use chemicals or solvents to clean the screen. Use only commercially available, water based de-greaser
- ▶ Do not use chemicals, solvents, or liquid cleaners to clean the Velux covering.

### VELUX COVERING

- Use a lint roller to remove particles from the black Velux material.
- A brush may be used to comb (lift) the nap of the Velux material to help eliminate depression marks.

### FOR NON-VINYL SCREEN MATERIAL

If you have concerns with one of our non-vinyl Stewart Filmscreen screen materials, contact tech support at Stewart Filmscreen.

## **ONE (1) YEAR LIMITED WARRANTY**

---

STEWART FILMSCREEN CORPORATION (Stewart) warrants all products to the original purchaser only. Stewart products are guaranteed to be free from defects in materials and workmanship for a period of one (1) year from the date of purchase by the original purchaser or eighteen (18) months from date of manufacture, as defined in the serial number. Additionally, all products must be properly operated and maintained according to Stewart instructions and cannot be damaged due to improper handling or treatment after shipment from the factory. This warranty does not apply to equipment showing evidence of misuse, abuse, or accidental damage, including neglect caused by improper installation (i.e. proximity to hot lights, exposure to extreme heat or cold, exposure to excessive humidity, etc.).

Stewart on-site warranty repair services are not available for this product. Stewart's sole obligation under this warranty shall be to repair or to replace (at Stewart's sole discretion) the defective part of the merchandise. This warranty expressly does not cover any costs of removal, installation, framing, or other costs incidental to replacing the screen or returning it to Stewart. Returns for service should be made to your Stewart dealer. If it is necessary for the dealer to return the screen or part to Stewart, transportation (freight) expenses to and from Stewart are payable by the purchaser. Stewart is not responsible for damage in shipment. To protect against damage or loss in transit, insure the product and prepay all transportation expenses.

This warranty is in lieu of all other warranties, expressed or implied, including warranties as to fitness for use or merchantability. Any implied warranties of fitness for use, or merchantability, that may be mandated by statute or rule of law are limited to the one (1) year warranty period. This warranty gives you specific legal rights, and you may also have other rights which vary from state to state. In no event will Stewart be liable for sums in excess of the purchase price of the product. No liability is assumed by Stewart for expenses or damages resulting from interruption in operation of equipment, or for incidental, direct, or consequential damages of any nature. In the event that there is a defect in materials or workmanship of a Stewart Filmscreen product, you may contact our Customer Service Department at 1161 W Sepulveda Blvd, Torrance, California 90502- 2797, or call us at 1 (310) 784-5300, or toll free at 1 (800) 762-4999.

**IMPORTANT:** This warranty shall not be valid and Stewart shall not be bound by this warranty if the product is not operated and maintained in accordance with Stewart's written instructions. Stewart Filmscreen Corporation shall not be liable for any and all consequential damage(s) occasioned by the breach of any written or implied warranty pertaining to the sale of a Stewart Filmscreen product in excess of the purchase price of the product sold.



The Reference for Stunning™

[www.StewartFilmscreen.com](http://www.StewartFilmscreen.com)

1161 W. Sepulveda Blvd., Torrance CA 90502 USA | 1 (800) 762-4999 | Tel: 1 (310) 784-5300 | Fax: 1 (310) 326-6870

Email: [TechSupport@StewartFilmscreen.com](mailto:TechSupport@StewartFilmscreen.com)

2022© Stewart Filmscreen. Specifications are subject to change without notice.

---