



G5 INSTALLATION & OPERATION MANUAL





TABLE OF CONTENTS

General Information 3
 Introduction 3
 Warranty..... 3
Safety 3
 Refrigerant 4
Installation Preparation..... 5
 Environmental Operation 5
 Space Requirements..... 5
 Plumbing Requirements..... 6
 Electrical Requirements 6
 Uncrating and Inspection 7
 Anti Tip Installation 7
 Door Orientation and Overlay 8
 Overlay Installation and Removal..... 8
 Hinge Direction 9
Installation 10
 Placing Unit..... 10
 Leveling Unit 10
 Front Grill Installation 10
 Shelving and Drawer..... 10
 Shelf and Drawer Weight Limits..... 10
 Shelving Installation and Adjustment 10
 Drawer Removal and Installation 10
 Power Unit On..... 11
 Loading Product..... 11
Controls 11
 Display Icon Definitions and Operations 11
 Controller Operation..... 13
 Master Switch..... 13
 Display 13
 Standby Mode 13
 Interior Light 13
 Quick Cool..... 13
 Display Lock..... 13
 Sabbath Mode..... 13
 Display Button Sound..... 13
 Select Unit of Measurement for Display Temperature..... 13
 Defrost Operation..... 14
 Return from Sub Menu..... 14
 Changing Temperature..... 14
 Time and Date..... 14
 Changing Humidity Percentage 14
 Alarm History..... 15
 Show Room Mode..... 15
 Diagnostic Window..... 15
Maintenance and Care 16
 Cleaning the Condenser 16
 Seasonal Maintenance For Unit Located Outdoor..... 16
 Winterizing 16
 Spring Start-Up 16



Led Replacement..... 17
 Stainless Steel Care & Cleaning..... 17
 Trouble Shooting..... 19
 Alarms and Faults..... 19
 Service and Repairs..... 20
 Service..... 20
 Repairs..... 20
 Decommissioning and Disposal..... 22
 Decommissioning and Disposal – (End of Life)..... 22
 Labels..... 22

GENERAL INFORMATION

Introduction

Congratulations on your purchase of a Perlick undercounter product. This manual has been prepared to assist you in the installation of your cabinet and to acquaint you with its operation and maintenance.

We dedicate considerable time to ensure that our products provide the highest level of customer satisfaction. If service is required, your dealer can provide you with a list of qualified service agents. For your own protection, never return merchandise for credit without our approval.

We thank you for selecting a Perlick product and assure you of our continuing interest in your satisfaction.

Warranty

Improper installation of this product may void warranty. Please review this manual for recommended installation.

Reference Warranty DOC#/Name

All warranty service will need to be performed by a Perlick-authorized service agent utilizing OEM parts.

To register your product, visit our web site at www.perlick.com. Click on “Residential” or “Commercial”, then “Resources”. Click on the link “Warranty and Support”. You must complete and

submit this form or the installation date will revert back to the ship date. Perlick URL for locating form/QR .

Please record the purchase date and the dealer’s name, address and telephone number below.



Serial Number is located on the inside nameplate on top center of the cabinet.

Model Number: _____

Serial Number: _____

Purchase Date: _____

Dealer Name & Address:

Phone Number: _____

SAFETY

PLEASE READ all instructions completely before attempting to install or operate the unit. Take particular note of the DANGER, WARNING, an CAUTION information in the manual. The information is important for the safe and efficient installation, operation and care of your Perlick unit.

⚠ DANGER Indicates a hazard that **WILL** result in serious injury or death if precautions are not followed.

⚠ WARNING Indicates a hazard **MAY** cause serious injury or death if precautions are not followed.



IMPORTANT!

Read and understand all information in this manual before attempting the installation. All plumbing and electrical work must be performed by a qualified technician and conform to all applicable state and local codes.

Keep hands away from pinch points on the equipment. For example, any area around the door hinges. This appliance is not intended for use by persons (including children) with reduced physical, sensory or mental capabilities, or lack of experience and knowledge, unless they have been given supervision or instruction concerning use of the appliance by a person responsible for their safety. Children should be supervised to ensure that they do not play with the appliance.

CAUTION Indicates a hazard where minor injury or product damage may occur if precautions are not followed.

NOTICE Indicates property damage MAY occur if warnings or instructions are not followed.

 The GHS pictogram diamond symbol indicates this product contains a flammable gas. This symbol is used within this manual and labels on the appliance.

 The red flame triangle symbol indicates this product contains a flammable gas. This symbol is used within this manual and labels on the appliance.

Refrigerant

 **CAUTION** This product contains a flammable refrigerant, R600a (Isobutane). The appliance shall be installed in accordance with the Safety Standard For Refrigeration Systems, ANSI/ASHRAE 15. All local, state, provincial, and federal laws must be followed for installation, handling, servicing, and disposal of the appliance.

R600a is a hydrocarbon. This refrigerant is flammable and is only allowed for use in appliances with fulfill the requirements of UL/CSA 60335-1, UL/CSA 60335-2-24, and UL/CSA 60335-2-89. Consequently, R600a is only allowed to be used in refrigerating appliances which are designed for this refrigerant and fulfill the abovementioned standard.

- R600a is heavier than air. The concentration will always be highest at the floor level.
- The explosion limits are as follows:
 - Lower Limit: 1.8% by volume
 - Upper Limit: 8.4% by volume
 - Ignition Temperature: 460°C

 **DANGER** Take caution when handling, moving and using the product to avoid damaging the refrigerant tubing or increasing the risk of a leak.

 **WARNING** Only service personnel that have the proper qualifications and training to safely work with flammable refrigerants and electricity should attempt to maintain, service, or repair the refrigeration and electrical system of this appliance. This includes but is not limited to breaking into the refrigeration circuit, opening of covers and enclosures, and service or repair any components of the electrical system.

CAUTION If service is necessary, repair work must be performed by a Perlick authorized servicer. Work done by unqualified individuals could potentially be dangerous and will void the warranty.

NOTICE This product contains blown foam insulation using blowing agent R611 (Methyl Formate). The foam in this product does not contain HFC's, CFC's, or HCFC's.

CAUTION This product uses R611 as a blowing agent for the foam insulation. R611 is mildly flammable. All local, state, provincial, and federal regulations must be followed when disposing of the appliance.

 **WARNING: California Prop 65 Notice**

These products may expose you to chemicals including Chromium, which are known to the state of California to cause cancer and birth defects or other reproductive harm. For more information on whether a product in this list contains these chemicals, please refer to the specific product page at perlick.com. Or to find out more about Prop 65, go to P65Warnings.ca.gov.



INSTALLATION PREPARATION

Environmental Operation

Coastal grade units are recommended for installations within 1 mile of the coast, but also up to 5 miles of the coast depending on local conditions. Coastal grade units are recommended if installed near a pool but are needed if installed near an indoor pool. Use of non-coastal grade unit may impact performance and may void warranty.

Application	Freezer	Refrigerator/Beverage	Wine
Lower Ambient Temperature	32 °F 0 °C	38 °F 3 °C	42 °F 5°C or below set point
Upper Ambient Temperature	105 °F 41 °C	105 °F 41 °C	105 °F 41 °C

NOTE: When environmental temperatures are below the lower ambient temperature limit reference Winterization in Maintenance section to prepare unit for winter storage. Once temperatures are above the lower ambient temperature limit, then reference the Spring Start-Up in Maintenance section.

Use outside of these conditions will have significant impact to performance, risk damaging the equipment, and may void warranty.

NOTE: Glass door units may sweat in conditions with relative humidity exceeding 75%.

This product identification label is marked as climatic class 5. This product has been tested in test room conditions of an ambient of 109° F (43° C).

Space Requirements

To ensure maximum performance, fresh air must be allowed to circulate through the machinery compartment. Do not place anything in front of the cabinet that would obstruct air flow at the grill. Do not place the unit in an unventilated small room.

NOTICE If the unit is installed under a countertop, it is recommended that the countertop be supported by surrounding cabinetry and use shims to support countertop directly above the refrigerated cabinet.

NOTICE Make sure the floor under the unit is level with the surrounding finished floor. Protect a finished floor with plywood, cardboard, or some other suitable material before moving the unit into place. Failure to do this may result in damage to the floor.

NOTE: Make sure the space opening is correctly sized for the unit. See chart below for finished rough opening requirements:

15" Standard Height		
Height	Depth	Width
34-7/8" minimum 35-1/2" maximum	24"	15"
24" Standard Height		
Height	Depth	Width
34-7/8" minimum 35-1/2" maximum	24"	24"
24" Shallow Depth		
Height	Depth	Width
32-15/16"	18"	24"
24" ADA-Compliant Series		
Height	Depth	Width
32-15/16"	24"	24"

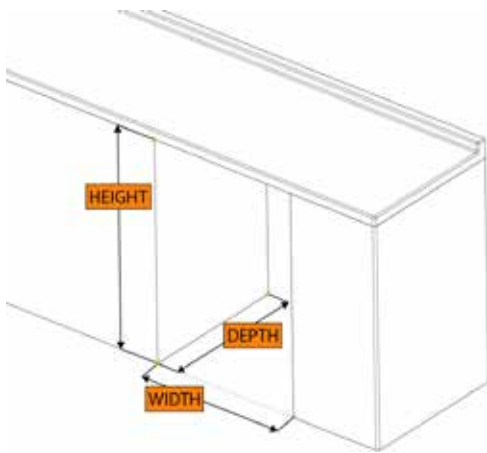

NOTE: For a cabinet door to open properly, the door must open a minimum of 90°. Use a minimum 2" filler in corner installations to assure a full 90° opening. Allow 25" clearance in front of unit for full door swing and shelf/drawer pull out for all units.

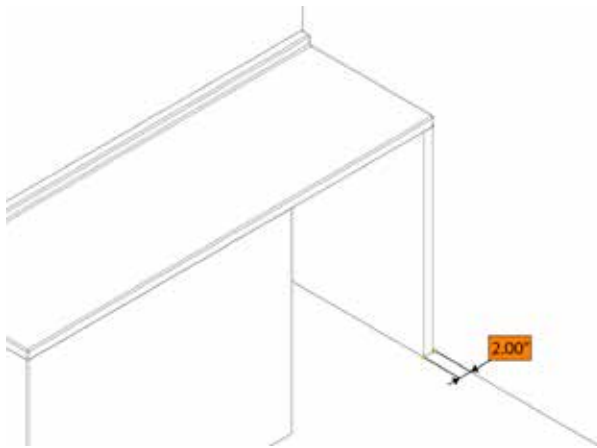

Perlick doors open to 105°. When installing a panel thicker than 3/4", or if located next to adjacent wall, the 90° hinge stop pin may be required to prevent damage to the unit and adjacent cabinetry/walls. This hinge pin must be installed prior to full integration.

1. Remove the cabinet hinge trim cover.
2. Open cabinet door approximately 45° to 85° to expose the hinge pin hole under hinge guard. Install the hinge pin into hole. Ensure hinge pin is fully seated to top of hinge to prevent damage to hinge guard.
3. Reattach the cabinet hinge trim piece.

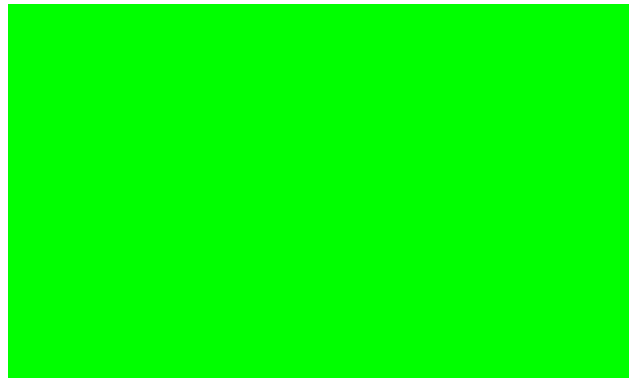

Check that the following are level and square:

- Front and interior opening
- Installation opening and floor surface
- Countertop bottom front edge

NOTE: The floor under the unit must be at the same level as the surrounding finished floor.

NOTICE

To prevent possible damage to the countertop, do not place heavy objects on countertop directly over unit.

Plumbing Requirements

No plumbing connections are required. Condensate from the cooling coil is automatically evaporated through a condensate pan located in the condensing section of the unit.

Electrical Requirements

For specifications, see data plate located on the cabinet.

⚠ WARNING Electrical work must be performed by a qualified technician and conform to all applicable state and local codes.

⚠ WARNING Inspect the electrical cord and plug for damage prior to energizing the unit to avoid potential electric shock. If the power supply cord is damaged, it must be replaced by a qualified service agent and with an OEM replacement power supply cord.

⚠ WARNING Use electrical grounding to avoid electrocution or electric shock. This appliance is equipped with a 3-prong (grounding) polarized plug for your protection against possible shock hazards. Never use an extension cord to connect the unit to the electrical source. Do not use a two-prong adapter or remove the power cord



ground prong. Failure to use grounding may result in death, serious injury, or property damage. Failure to use grounding will void warranty.

NOTE: For best operations, it is not recommended to use a Ground Fault Circuit Interrupter (GFCI) or Arc-Fault Circuit Interrupter (AFCI) for indoor use, follow local codes. Outdoor use reference local codes on GFCI and AFCI use.

Electrical Supply 115 V-AC, 60Hz

Service 15 amp dedicated circuit

Receptacle 3-Prong, Grounded Nema 5-15 R

Uncrating and Inspection

Upon receipt of the unit, inspect packaging for damage. If any damage is found, contact the freight company associated with shipping your product. If no visible damage is found, remove all packing material and carefully inspect for hidden damage. If damage is discovered, file your claim immediately with local dealer or distributor. Perlick is not responsible for damage in transit.

[Reference FOB policy](#)

⚠ WARNING Do not use or store flammable liquids (ie; gasoline) or vapors near the appliance to avoid fire.

⚠ WARNING Do not store explosive substances such as aerosol cans with a flammable propellant in this appliance.

⚠ WARNING To prevent personal injury, a minimum of two people are required to lift the unit. Larger units may require additional personnel.

⚠ CAUTION Do not lift unit by drawer, shelving or door handles, as damage to the unit could occur if not moved as instructed.

NOTICE When moving the unit, be sure to protect finished flooring with appropriate material to avoid damage from moving the unit.

NOTE: Before moving the unit, secure the door shut with tape to prevent door from swinging open while being moved. Carefully move unit to installation site and place in front of opening.

NOTICE

Fully retract the legs prior to moving to prevent damaging the unit or floor.

NOTICE

If unit has been tilted past 45 degrees or laid on its back or sides, place unit upright and allow a minimum of 24 hours before connecting power. Failure to follow this procedure may damage the compressor and void the warranty.

Anti Tip Installation

A set of anti-tip brackets is supplied with the unit. These brackets should be attached to the floor at the rear of the unit. Each bracket must be located to engage the rear glides when the cabinet is pushed back into position.

[Reference diagram how to install](#)



For free-standing units an anti-tip bracket is supplied with the unit.

NOTICE

If installing on a concrete floor, concrete fasteners are required and not included with the anti-tip kit.

NOTICE

Some installation sites may require modifications to provide a secure surface for attaching the brackets.

Overlay Installation and Door Orientation

Overlay Installation and Removal

Before beginning installation, check all components for proper fit and finish.

Wood Overlay

Build the overlay per the overlay template, can be found on www.perlick.com. The shoulder bolt must be attached to the wood overlay prior to installation. Handle should be installed to the overlay prior to installing overlay to the door.



NOTE: When installing handle(s) in wood overlay(s), use countersunk flathead fasteners.

CAUTION For best performance and functionality, the overlay panels should be no more than 3/4" thick. The weight of the overlays should not exceed 20 lbs for solid (-2) doors, 10 lbs for glass (-4) doors, or 10 lbs for each drawer (-6) models.

1. Lift door overlay up against the door.
2. Align shoulder bolt on the overlay to the top of the slot in the door.
3. Once the shoulder bolts are aligned, push the overlay against the door. Then slide the door down until the shoulder bolts slide to the bottom of the slots.

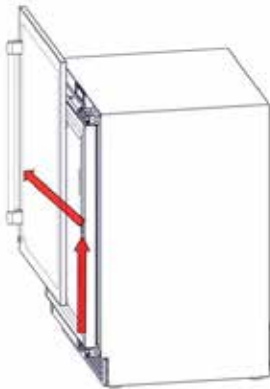

4. Remove the hinge cover bracket to access the tilt support bracket with Phillips head screwdriver.

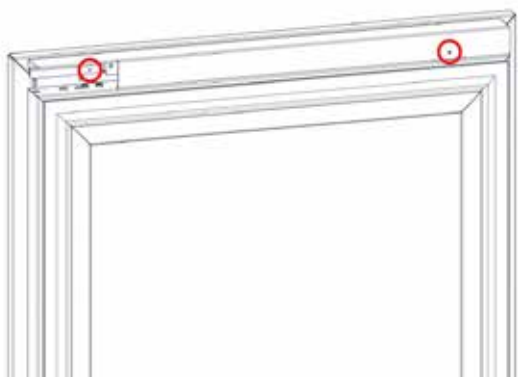

5. With a Phillips head screwdriver, secure the overlay to the tilt support bracket with the appropriate screws.



6. Level the overlay by adjusting standoffs in the top bracket with a 4 mm allen key, can use leveling leg tool.

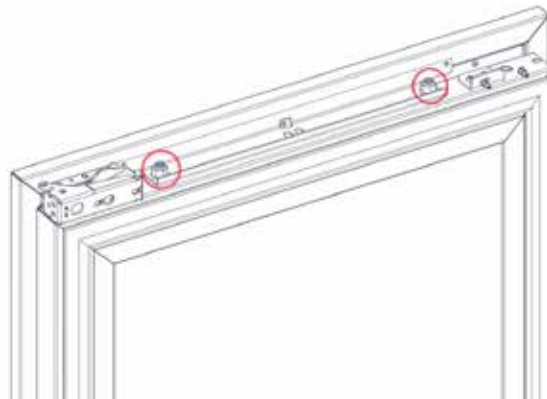

7. Use a Phillips head screwdriver to attach the bottom overlay bracket to the overlay with screws.



8. Install the hinge cover bracket to over the upper tilt support bracket.

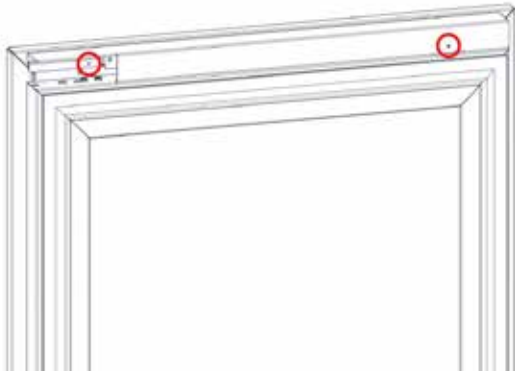

Uninstallation of the overlay is done using the reverse order of the installation instructions.

NOTE: Once screws are removed from the tilt support brackets, **slide the overlay up** so the shoulder bolts can clear the slot.

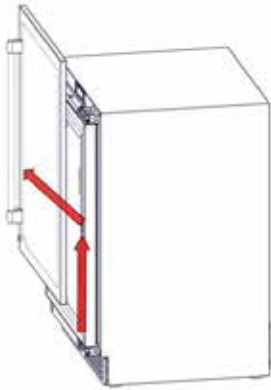

Hinge Direction

NOTE: An additional person is recommended to hold and align the door.

1. Uninstall Overlay.
2. Close the cabinet door.
3. With the help of another person holding the door, remove the bottom screws from the bottom hinge to the door.
4. While holding the door, remove the top screws from the top hinge.



5. Gently set door to the side to avoid damaging the door.
6. Use a Phillips Screwdriver to remove the top and bottom hinge from the unit.
7. Cross the hinge location when changing hinge direction:
 - a. Reattach the top hinge to the bottom corner.
 - b. Reattach the bottom hinge to the top corner.

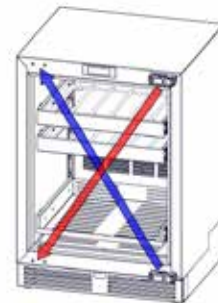

8. Lift door up against the unit. Secure the top and bottom hinge brackets to the hinges with screws.





INSTALLATION

Placing Unit

- Prior to sliding the unit into location, plug in the unit in.
- Slide the unit into position in the opening.
- Push the unit into the opening until the bottom front edge of the unit is flush with the surrounding cabinetry.



Leveling Unit

Front and rear leveling legs can be adjusted from the front once the unit is positioned. Remove the grill to access leveling adjustment access holes.

Once the unit is in position, any height adjustment can be made from the front. Using the hex driver leveling tool, turn the hex driver clockwise to raise the unit or counterclockwise to lower.



When the unit is properly leveled, door adjustments are less likely to be necessary.

CAUTION Level the unit to the floor, not to the surrounding cabinetry. This could affect the operation of the unit, such as door closing.

WARNING To reduce the possibility of the unit tipping forward, the front leveling legs must be in contact with the floor.

Front Grill Installation

Once the unit is secured in place, install the louvered front grill. Secure the plate by snapping the latch into the latch catch on the unit.

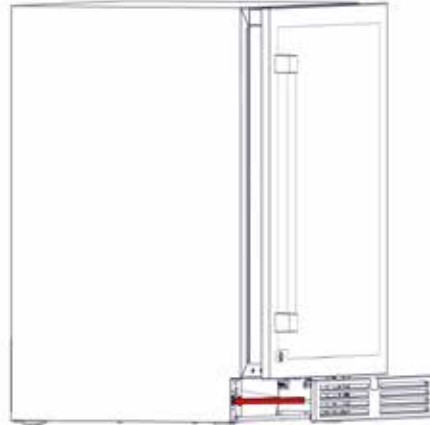

NOTICE This unit requires proper ventilation to operate correctly. Do not block the louvers on the front grill or place product directly in front of the evaporator fan motor and evaporator cover louvers. Obstructed ventilation can lead to poor performance and compressor damage.

Shelving and Drawer

Shelf and Drawer Weight Limits

Style	Load Limit
Wine Rack	70 lbs
Wire Form Shelf	70 lbs
Premium Stainless Steel	70 lbs
Drawer	75 lbs

NOTICE If shelf or drawer is overloaded, it may cause damage to the undercounter.

Shelving Installation and Adjustment

NOTE: Improper shelf/drawer installation may not actuate slide mechanism.

CAUTION Completely empty shelf or drawer before removing.

1. Pull the shelf out to its furthest position. Locate the tabs in the middle of both extenders. Pull both tabs toward yourself, and pull shelf out.



2. Remove each shelf bracket separately. Grasp the middle of the bracket, lift the back up, then pull forward to remove.



3. Position each shelf bracket separately. Grasp the middle of the bracket, lift the back up, then pull forward to remove.
4. Repeat steps 1 through 3 for other brackets.
5. Push extenders completely into brackets. Align the shelf/drawer grooves with the extenders and slide completely into the unit.

Drawer Removal and Installation

Removal: Pull the drawer out to its furthest position. Locate the tabs in the middle of both extenders. Lift one tab up while pushing the opposite tab down, and pull drawer out.



Installation: Push extenders completely into brackets. Align the shelf/drawer grooves with the extenders and slide completely into the unit.

Power Unit On

Once the unit is installed and level, verify the master switch behind the front grill is in the on position. Follow the instructions to set the date, time, and temperature are in the Display Operation section.

Loading Product

Before storing any product, power unit on and allow it to operate for 24 hours to allow temperatures to stabilize. When loading product into the unit, do not block internal louvers and fan guard openings or performance will be decreased.

CONTROLS

Display Icon Definitions and Operations



Increase Icon



Decrease Icon



Confirm Icon



Cancel Icon



Return Icon



Display Lock Icon



Power Icon



Sabbath Mode Icon



Button Sound Icon



Display Light Icon



Display Lighting Color Icon



Service Menu Icon



Humidity Setpoint Icon



Unit of Measurement Icon



Quick Cool Icon



Active Alarm Icon



Alarm History Icon



Trash Icon



Evaporator Defrost Icon



Manual Cabinet Defrost Icon

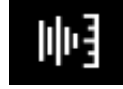

Diagnostics Icon



Time Date Icon



Showroom Display Mode Icon

Main Screen Screen when door opens



Screen 2 Swipe right from main



Screen 3 Swipe right from screen 2



Screen 4 Swipe right from screen 3



Service Menu Screens Inside of selected menu





Controller Operation

Master Switch

Under Counter units come equipped with a master power switch located behind the louvered toe kick. Remove the toe kick to turn power on or off to the unit. Pull on each side of the toe kick to remove.

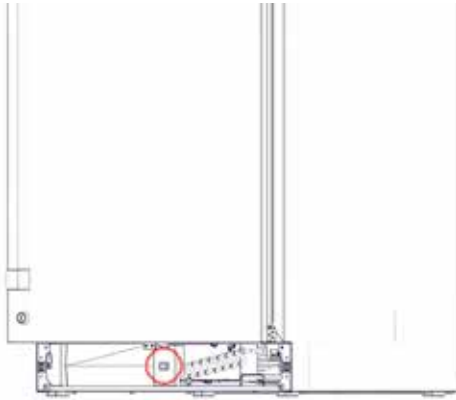

Display



The display will turn on once the door is opened. The display will remain on for 30 seconds after the door is closed.

Standby/Power Off Mode

To place unit into standby mode, tap the power  icon on display and activate standby mode. Then confirm that you want to turn off unit. In standby mode, the unit still has power going to all components. Do not attempt repairs/service when in standby mode.

Interior Light

Under Counter units are equipped with an interior light that will illuminate when the door/drawer is opened. When unit is open the LED will turn to a cool white color.

All glass door units have color LED ambiance light for when door is closed. To enable or disable the display light, swipe display till the display light icon, . A greyed out light icon will indicate interior lights are disabled. LED light can be changed, to access color menu swipe display to the  icon and select the icon. Once in the color adjustment menu change to desired color. Desired color only displays when the door is closed.



Quick Cool

The Quick Cool feature accelerates cooling cycle to bring cabinet to temperature, useful for after loading products. Quick Cool automatically activates after initial power up. To activate Quick Cool, select the  icon. Quick Cool will terminate automatically once the setpoint is achieved or when the icon is selected a second time to disable quick cool.



Display Lock

The Display Lock prevents settings from being adjusted when activated. While the display is locked, you can swipe through screens, activate quick cool, and silence alarms. To activate the Display Lock, select the  icon. Will be prompted to confirm enabling the lock screen. To unlock the screen, hold the Display Lock icon for 3 seconds. A greyed out icon will indicate the display lock is disabled.

Sabbath Mode

To activate Sabbath Mode, select the  icon. A greyed out icon indicates the unit is not in Sabbath Mode. There will be a prompt to confirm activation of Sabbath Mode. Once Sabbath Mode is activated, the display will not power on. To reactivate, hold finger in the center of the display for 15 seconds to power on the display. Then tap on the  icon for 5 seconds to deactivate Sabbath Mode.

Display Button Sound

The Display Button Sound Icon enables and disables the sound when interacting with the display. To disable sound, swipe display menu until the  icon is visible. Select the  icon, the user will be prompted to confirm disabling sound. A greyed out display button sound icon indicates the sound for display buttons is disabled. Alarms will still sound when display button sound is disabled.

Select Unit of Measurement for Display Temperature

To alternate between Fahrenheit and Celsius, find the unit of measurement (UoM) icon. Then select the  or  icon until desired UoM is selected.



Defrost Operation

Manual Evaporator Defrost

The under counter unit is designed to complete automatic defrost on its own. The standard defrost operation is intended to assist in maintaining and servicing the unit. Swipe the display to the standard defrost icon, then select the  icon. The user will then be prompted to confirm the start of a defrost. After completion of a standard defrost the automatic defrost will resume.

NOTE: *If the evaporator is too warm, or in quick cool mode, then unit will not initiate the defrost.*

Manual Cabinet Defrost

The Manual Defrost completes an extended 6 hour defrost. The end user will initiate manual defrost after every shift to prevent excessive ice build up on the coils. Swipe the display until you are at the manual defrost icon, then select the  icon. The user will then be prompted to confirm the start of the manual defrost. After completion of a standard defrost the automatic defrost will resume.

NOTE: *Only available on the UCC24F and UCA24F models*

Return from Sub Menu

To return to the previous screen, select the  icon.

Changing Temperature

Single Zone

To change the temperature select the displayed temperature on the screen. Then increase or decrease the temperature as desired. Once temperature is at desired set point click the confirm icon, .





Dual Zone

On a dual zone unit there are two temperatures displayed on the screen. To change the temperature, select the temperature desired to be changed. Then increase or decrease the temperature to a new set point and select confirm

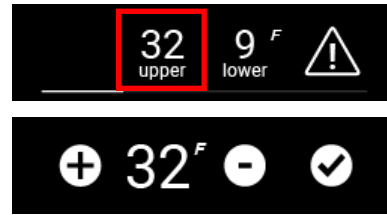
icon. To change the other set point, select the display temperature and increase or decrease to a new set point then select confirm icon. Left temperature is the higher temperature correlating to the upper compartment of the unit.



Time and Date

The date and time must be set for the unit upon installation. All alarms will be time stamped based on the set date and time. To set the date and time select the Service Menu Icon . Then select the Time and Date icon .

Time and Date will be preserved in the event of a power loss. If an extended power loss occurred, then verify the date and time are set correctly. To change the date and time see below:

- To change the time, hour then increase or decrease as needed, select confirm icon once at correct hour. Select the minutes, increase or decrease to correct minute, select confirm. Change between AM and PM by selecting the "A" or "P" icon.



- To change the date, swipe right to access the date menu. Select month and change to correct number and confirm. Repeat with the day and year for the date, then select confirm icon when whole date is correct.

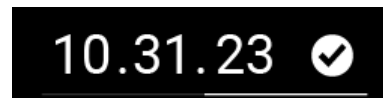

Changing Humidity Percentage

The humidity percentage adjustment is only available on wine units, including dual zone units with wine zone(s). To change the humidity percentage, select the Humidity Percentage icon . Increase or decrease the humidity to preferred humidity percentage, then select the confirm icon.





Alarm History

To access the alarm history, select either the Active Alarm icon, or select the Service Menu icon, then select the Alarm History icon. Once inside the menu, swipe left and right to review all the stored alarms, the alarms will be date and time stamped. The alarm history stores up to ten past alarms.



Or

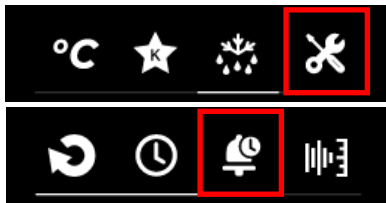

- To clear all alarm history, swipe to the Clear History screen. Select the clear history icon. A prompt will appear to confirm clearing history.

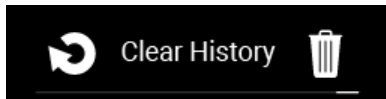

- If no stored alarms exist, the "No Alarm History" prompt will appear.

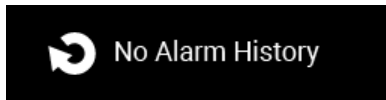

Show Room Mode

Showroom mode is intended for units that are being used solely for display purposes. Showroom mode has the user interface fully functional along with the cabinet lights, however, no compressor, evaporator fans or condenser fans will operate.

To enter show room mode, select the Service Menu icon and swipe right on screen. Then select the show room icon. Once selected, the user will be prompted to confirm enabling show room mode. A greyed out icon indicates show room mode is disabled.



Diagnostic Window

To access the diagnostic window, first select the service menu icon. Then select the Diagnostic Window icon to open the display. The diagnostic display window is useful whenever submitting a service ticket for remote diagnostics.



ZONE 1 TEMP	[10] °F	E. FAN OUTPUT	[100] %
ZONE 2 TEMP	[36] °F	C. FAN OUTPUT	[60] %
EVAP. TEMP	[-10] °F	DOOR SW 1	[CLOSED]
COND. TEMP	[105] °F	DOOR SW 2	[OPEN]
HUMIDITY	[50] %	HOT GAS VLV.	[CLOSED]
COMP. OUTPUT	[75] %	AIR DAMPERS	[CLOSED]

Zone 1 Temp: For single zone is the cabinet temperature. If dual zone than the lower or colder section.

Zone 2 Temp: Only for dual zone units for the upper warmer zone.

Evap. Temp: Temperature at the evaporator inlet.

Cond Temp: Temperature of the outlet of the Condenser.

Humidity: On wine units, the humidity sensor is installed and will display the humidity percentage.

Comp. Output: Gives the percentage of max speed the variable speed compressor is running.

E. Fan Output: Percentage of max speed the fan is running on the evaporator.

C. Fan Output: Percentage of max speed the fans are running on the condenser.

Door SW 1: On single zone units, it identifies if the door is open (OPEN), or closed (CLOSED). For drawer units, it displays data on the lower drawer.

Door SW 2: Only on drawer units, it identifies if the top drawer is open or closed.

Hot Gas Vlv.: Only on low temperature units or dual zone units with a freezer section, this identifies if the hot gas solenoid valve is ON or OFF.

Air Dampers: Only for dual zone units, identifies if the damper is open or closed.



MAINTENANCE AND CARE

 **WARNING** Keep ventilation openings, in the appliance enclosure or in the built-in structure, clear of obstruction.



Cleaning the Condenser

 **WARNING** Do not use means to accelerate the defrosting process or to clean the evaporator and/or condenser coil other than those recommended by the Perlick technical service team.

 **CAUTION** Avoid damaging or crushing the condenser fins or tubing.

Every 30 days is recommended to clean the condenser for optimal performance.

1. Remove front grill.
2. Using a soft bristle brush or brush attachment on a vacuum, remove all dust and debris from the condenser.
3. Verify no fins are damaged or bent. Use a condenser comb to correct if any were bent.

  **DANGER** Flammable Refrigerant. Risk of fire or explosion. Do not damage refrigeration tubes.

 **CAUTION** Avoid damaging or crushing the condenser fins or tubing.

  **WARNING** Do not use any electrical appliances inside the food storage compartments of the appliance.

Seasonal Maintenance for Units Located Outdoor

Winterizing

1. This process should occur when the daily low temperatures are at or below environmental operation temperatures, seen in the Environment Operations Table.
2. Terminate power to the unit using one or more of the following options:
 - a. Turn the master switch located behind the grill off.
 - b. Unplug the power cord from electrical receptacle.

- c. Turn off the circuit breaker to the electrical receptacle the cabinet is plugged into.
3. Remove all contents from the unit.
4. Remove the front grill.
5. Clean the condenser by using a vacuum cleaner to remove loose debris (leaves, dirt, etc.) that may have accumulated inside the grill.
6. Reinstall the front grill.
7. Clean the interior and exterior of the unit using stainless steel cleaner and polish.

NOTICE

Do not place a cover over the unit. While not required, you may choose to remove the unit from the outdoor location and store indoors.

 **CAUTION** Operating the unit at temperatures lower than those recommended will void the warranty.

Spring Start-Up

This process should occur after the daily low temperatures are above the environmental operation temperatures, seen in the Environment Operations Table.

1. Remove the front grill.
2. Check the condensing unit to ensure it is clear of loose debris, and clean as necessary with a vacuum cleaner.
3. Reattach the front grill to the unit.
4. Clean the interior and exterior of the unit using stainless steel cleaner and polish.
5. Return power to the unit by:
 - a. Plug the unit into the electrical receptacle or turn on the circuit breaker.
 - b. Turn on the master switch located behind the grill. The controller display will then turn on.
6. The cooling process will begin to bring the unit to the set point temperature. It's recommended you run the unit for 24 hours to stabilize the operating temperature before using.



⚠ DANGER Never attempt to repair or perform maintenance on the unit until the main electrical power to the unit has been disconnected!

Led Replacement

If an LED replacement is required, call your Perlick Factory Authorized Service Center. For the location of the Service Center in your area, contact your selling dealer, inquire via the web at www.perlick.com, E-mail us at warrantyserv@perlick.com, or call 844-411-8050.

Stainless Steel Care & Cleaning

General

Stainless steel is a “passive” metal because it contains other metals like chromium, nickel and manganese that stabilize the atoms. Chromium provides an invisible passive film that covers the steel surface, acting as a shield against corrosion. If the film is intact and not contaminated, the metal is passive and stainless. If the passive film of stainless steel has been broken, equipment can start to corrode and rust.

The following materials or processes can break down stainless steel’s passive layers and allow corrosion to occur:

Mechanical abrasion refers to items that will scratch a steel surface. Steel pads, wire brushes and scrapers are prime examples.

Water comes out of the faucet in varying degrees of hardness. Hard water may leave spots. When allowed to sit, these deposits will break down the passive chromium layer and rust stainless steel. Other deposits from food preparation must be promptly removed with an appropriate cleaning agent.

Chlorides are found nearly everywhere. They are in water, food, and table salt. Household and industrial cleaners are the worst offenders.

Preventing Stainless Steel Rust

Use non-abrasive tools to clean stainless steel products. Soft cloths and plastic scouring pads will not harm the steel’s passive layer.

Clean with polish lines. Some stainless steels have visible polishing lines or “grain”. When visible lines are present, always scrub in a motion parallel to the lines. When the grain cannot be

seen, polish in a consistent straight pattern and not in a circular motion.

Use alkaline, alkaline chlorinated or non-chloride containing cleaners. While many traditional cleaners are loaded with chlorides, the industry is providing more options of non-chloride cleaners to consumers. If you are not sure of chloride content in the cleaner being used, contact your cleaner supplier. If your cleaner contains chlorides, ask your supplier for an alternative. Avoid cleaners containing quaternary salt; it also can attack stainless steel and cause pitting and rusting.

Keep food equipment clean. Use alkaline, alkaline chlorinated or non-chloride cleaners at recommended strength. Clean frequently to avoid build-up of hard, stubborn stains. The single most likely cause of damage is chlorides in the water. Remember, adding heat to cleaners that contain chlorides dramatically increases their effect on stainless steel.

If chlorinated cleaners are used, immediately rinse and wipe equipment and supplies dry. The sooner you wipe standing water, especially when it contains cleaning agents, the better. After wiping equipment down, allow it to air dry. Oxygen helps maintain the stainless steel passive film.

Cleaning the Cabinet Interior/Exterior

NOTICE NEVER use hydrochloric acid (muriatic acid) on stainless steel. Do not use abrasive cleansers or cloths on any interior or exterior surfaces or removable parts.

Glass panels may be cleaned using any standard glass cleaner available on the market.

To clean interior and exterior non-metallic surfaces and removable parts, wash with mild solution of soap and lukewarm water with a little baking soda. Rinse and dry thoroughly. Avoid getting water on the lights, controllers, fan motors and unfinished wood wine rack faces.



Job	Cleaning Agent	Comments
Routine Cleaning	Soap, ammonia, detergent	Apply with sponge or soft cloth.
Fingerprints and smears	Areal 20, Lac-O-Nu, Lumin Wash, O-Cedar Cream Polish	Provides barrier film to minimize fingerprints. Can be used on all finishes. Rub the surface with a cloth as directed on the package.
Stubborn stains and discolorations	AllChem Concentrated Cleaner, Samae, Twinkle, Cameo Copper Cleaners, Grade FFF Italian Pumice Whiting, Steel Bright, Lumin Cleaner, Zud Restoro, Sta-Clean, Highlite Cooper's Stainless Steel Cleaner or Revere Stainless Steel Cleaner	Apply with a damp sponge or cloth, then rinse with clear water and wipe dry.
	Old Dutch, Lighthouse Sunbrite, Wyandotte Bab-O, Gold Dust, Sapollo, Bon Ami or Comet	For these household cleaners, rub with a damp cloth. They may contain chlorine bleaches so rinse thoroughly after use and wipe dry.
	Liquid NuSteel or Dubois Temp	For these products, rub the surface with a dry cloth using only a small amount of cleanser. Rinse with water and dry.
Heat tint or heavy discoloration	Penny-Brite, Copper Brite, Paste Nu-Steel, Dubois Temp or Tarnite	Rub onto surface with a dry cloth.
Tenacious deposits, rust, discoloration, industrial atmospheric stains	Bar Keepers Friend, Revere Stainless Steel	When using these cleaners, apply with a damp sponge or cloth, rinse thoroughly and wipe dry.
	Oakite No. 33 Dilac, Texo NY, Flash-KlenzCaddy Cleaner, Turco Scale 4368 or Permag 57	Swab and soak with a clean cloth. Let stand for 15 minutes or more according to directions on package, then rinse and wipe dry.
Rust discoloration or corrosion caused by cleaning agents containing hydrochloric (muriatic) acid or chlorine bleach	3M Scotch Pad, type A, grade "fine"	Clean off the surface soil using cleaning methods above. Then rub discolored or corroded areas lightly with a dry pad.
Use of property names is intended only to indicate a type of cleaner and does not constitute an endorsement. Omission of any proprietary cleaner does not imply its inadequacy. All products should be used in strict accordance with instructions on the package.		
NOTE: Do NOT use steel wool or scouring pads to clean stainless steel.		

For Product Information:

- Contact your selling dealer.
- Inquire via the web at perlick.com
- Call 844-411-8050 for factory assistance on planning installation or product information
- Write to Perlick Corporation, Customer Service Department, 8300 West Good Hope Road, Milwaukee, WI 53223



For Product Service:

- Check the model and serial number of your unit located on the label attached to the inside top of the cabinet.
- Inquire via the web at www.perlick.com
- Call 844-411-8050 for factory assistance
- Email us at warrantyserv@perlick.com

- Inquire via the web at www.perlick.com
- Call 844-411-8050 for factory assistance
- Email us at warrantyserv@perlick.com

For Replacement Parts and Accessories:

- Use only genuine Perlick replacement parts and accessories. Genuine Perlick parts and accessories are designed to work correctly with Perlick products and offer superior service life. The use of non-Perlick parts can damage the unit and may void the warranty.
- Check the model and serial number of your unit located on the label attached to the inside top of the cabinet. Call your Perlick Factory Authorized Service Center.

Trouble Shooting

If the unit appears to be malfunctioning, read through the OPERATION section of this manual first. If the problem persists, check this trouble-shooting section to see if you can refer to the cause and remedy of the problem and resolve it without a service call.

⚠ DANGER Never attempt to repair or perform maintenance on the unit until the main electrical power to the unit has been disconnected!

Alarms and Faults

Error Code	Fault	Resolution
UIX	Display Communication Fault	Reset power to unit, either using rocker switch or breaker. If fault continues: Call Service: +1 844-411-8050
MEM	MC Memory Fault	
TCX	Extra High Condenser Temperature	Call Service: +1 844-411-8050
TEX	Evaporator temperature exceeds safe operation zone	Call Service: +1 844-411-8050
TEY	Extra Low Evaporator Temperature	Run a manual defrost for unit. If the alarm repeats within a week: Call Service: +1 844-411-8050
DO2	Door Opening Long Period	Close the door and activate a defrost cycle.
P1F	Zone 1 Probe Fault	Acknowledge code. Activate a defrost cycle. If the alarm repeats within a week: Call Service: +1 844-411-8050
P2F	Zone 2 Probe Fault	
PEF	Evaporator Probe Fault	
TCL	Low Condenser Temperature	Clean condenser coils per maintenance instructions. If the alarm repeats within a week: Call Service: +1 844-411-8050
PWR	Power Outage	Verify the correct date and time are entered in the date and time menu.
T1H	High Zone 1 Temperature	Acknowledge code. Activate a defrost cycle. If the alarm repeats within a week: Call Service: +1 844-411-8050
T1L	Low Zone 1 Temperature	
T2H	High Zone 2 Temperature	
T2L	Low Zone 2 Temperature	
TCH	High Condenser Temperature	Clean condenser coils per maintenance instructions. If the alarm repeats within a week: Call Service: +1 844-411-8050
TEL	Low Evaporator Temperature	Activate a defrost cycle. If the alarm repeats within a week: Call Service: +1 844-411-8050



DO1	Door Opening Short Period	Close the door.
PCF	Condenser Temperature Fault	Acknowledge code. Clean condenser. If the alarm repeats within a week: Call Service: +1 844-411-8050
PHF	Humidity Sensor Fault	
FCF	Condenser Fan Fault	Call Service: +1 844-411-8050
FEF	Evaporator Fan Fault	
F2F	Zone 2 Fan Fault	

SERVICE AND REPAIRS

Service

⚠ WARNING All service work and repairs should be performed by Perlick-authorized service personnel. All component parts shall be replaced with like components. Incorrect parts or improper service may result in injury, damage to property, or fire. All warranty service will need to be performed by Perlick authorized service agent using only OEM parts.

For Product Service:

- Check the model and serial number of your unit located on the label attached to the inside top of the cabinet.
- Inquire via the web at www.perlick.com
- Call 844-411-8050 for factory assistance
- Email us at warrantyserv@perlick.com

Repairs

⚠ WARNING Ensure that the area is in the open or that it is adequately ventilated before breaking into the system or conducting any hot work. Proper ventilation must be present during the period that the work is carried out. The ventilation should safely disperse any released refrigerant and preferably expel it externally into the atmosphere.

⚠ WARNING When performing any service or repair work, all wiring and cabling should be inspected to ensure that it will not be subject to wear, corrosion, excessive pressure, vibration, sharp edges, or any other adverse environmental effects. This inspection shall also take into account the effects of aging or continual vibration from sources such as compressors or fans.

Leak Detection of Flammable Refrigerants

⚠ DANGER Under no circumstances shall a potential sources of ignition be used in searching for or detection of refrigerant leaks. A halide torch (or any other detector using a naked flame) shall not be used.

The following leak detection methods are permissible with **flammable refrigerants**:

- Electronic leak detectors that have adequate sensitivity and are calibrated. Ensure the electronic leak detector is suitable for being used with **flammable refrigerants** and are set at the appropriate LFL for R600a.
- Soap and bubble method.

If a leak is suspected, all naked flames shall be removed and/or extinguished.

If a leakage of refrigerant is found which requires brazing, all refrigerant shall be recovered from the system, or isolated (by means of shut off valves) in a part of the system remote from the leak.

Refrigerant Removal & System Evacuation

⚠ DANGER When breaking into the refrigerant circuit to make repairs it is important that best repair practices are always followed due to the flammability of the refrigerant. The following procedure shall be adhered to:

- Safely remove refrigerant following local and national regulations
- Purge the circuit with inert gas
- Evacuate
- Purge with inert gas
- Open the circuit by cutting or brazing



The refrigerant charge shall be recovered into the correct recovery cylinders if venting is not allowed by local and national codes. The system shall be purged with oxygen-free nitrogen to render the appliance safe for **flammable refrigerants**. This process might need to be repeated several times. Compressed air or oxygen shall not be used for purging refrigerant systems.

Refrigerant purging is achieved by breaking the vacuum in the system with oxygen-free nitrogen and continuing to fill until the working pressure is achieved. The gas is then vented into the atmosphere, and finally pulling down to a vacuum. This process shall be repeated until no refrigerant is within the system. When the final oxygen-free nitrogen charge is used, the system shall be vented down to atmospheric pressure to enable work to take place.

Ensure that the outlet for the vacuum pump is not close to any potential ignition sources and that ventilation is available.

Recovery Of Flammable Refrigerants

⚠ DANGER When removing refrigerant from a system, either for servicing or decommissioning, it is recommended good practice that all refrigerants are removed safely.

When transferring refrigerant into cylinders, ensure that only appropriate refrigerant recovery cylinders are employed. Ensure that the correct number of cylinders for holding the total system charge is available. All cylinders to be used are designated for the recovered refrigerant and labelled for that refrigerant (i.e., special cylinders for the recovery of refrigerant). Cylinders shall be complete with pressure-relief valve and associated shut-off valves in good working order. Empty recovery cylinders are evacuated and, if possible, cooled before recovery occurs.

The recovery equipment shall be in good working order with a set of instructions concerning the equipment that is at hand and shall be suitable for the recovery of all appropriate refrigerants including, when applicable, **Flammable Refrigerants**.

Flammable Refrigerant Charging Procedure

⚠ DANGER In addition to conventional charging procedures, the following requirements shall be followed:

- a. Ensure that contamination of different refrigerants does not occur when using charging equipment.
- b. Hoses or lines shall be as short as possible to minimize the amount of refrigerant contained in them.
- c. Cylinders shall be kept in an appropriate position according to the instructions.
- d. Ensure that the refrigerating system is earthed prior to charging the system with refrigerant.
- e. Label the system when charging is complete (if not already).
- f. Extreme care shall be taken not to overfill the refrigerating system.

Prior to recharging the system, it shall be pressure-tested with the appropriate purging gas. The system shall be leak-tested on completion of charging but prior to commissioning. A follow up leak test shall be carried out prior to leaving the site.



DECOMMISSIONING AND DISPOSAL

R-600 Class A3 Flammable Refrigerant Used



DANGER



Risk of Fire or Explosion. Flammable Refrigerant Used.

It is important to decommission and dispose of this product in accordance with all federal, state, and local regulations.

 **DANGER** Risk of child entrapment. Before you throw away your old refrigerator or freezer:

- Take off the doors.
- Leave the shelves in place so that children may not easily climb inside.

  **WARNING** Do not use mechanical devices or other means to accelerate the defrosting process, other than those recommended by the manufacturer.

  **WARNING** Do not use means to accelerate the defrosting process or to clean the evaporator and/or condenser coil other than those recommended by the Perlick technical service team. If the appliance is going to be decommissioned and stored, it shall be stored in a room without continuously operating ignitions sources such as open flames, gas appliances, or electric heaters. Do not pierce or burn. Be aware that refrigerants may not contain an odor.

- Be sure to follow all the Important Safety Information located at the beginning of this manual as well as the Important Safety Information located in the Service & Repairs section of this manual prior to any decommissioning & disposal work.

Decommissioning & Disposal – (End of Life)

- Servicing shall be done by trained service personnel with certified competence in handling **flammable refrigerants** to minimize the risk of possible ignition due to improper service.
- Follow handling instructions carefully in compliance with national regulations.

- Do not puncture refrigerant tubing. Risk of fire or explosion due to puncture of refrigerant tubing; follow handling instructions carefully.
- The appliance contains a **flammable refrigerant** and must be disposed of in accordance with applicable national, state, and local codes and regulations. Refrigerant must be recovered and safely disposed of by properly trained service personnel.
- Prior to disposal of this product the refrigerant must be completely removed.
- When removing refrigerant from a system, it is recommended and good practice that all refrigerants are removed safely.
- Before carrying out this procedure, it is essential that the technician is completely familiar with the equipment and all its detail. It is recommended good practice that all refrigerants are recovered safely. Prior to the task being carried out, an oil and refrigerant sample shall be taken in case analysis is required prior to re-use of recovered refrigerant. It is essential that electrical power is available before the task commences.
- The recovery equipment shall be in good working order with a set of instructions concerning the equipment that is at hand and shall be suitable for the recovery of **flammable refrigerants**. In addition, a set of calibrated weighing scales shall be available and in good working order. Hoses shall be complete with leak-free disconnect couplings and in good operating condition. Before using the recovery machine, check that it is in satisfactory working order, has been properly maintained and that any associated electrical components are sealed to prevent ignition in the event of a refrigerant release. Consult manufacturer if in doubt.
- **Before refrigerant recovery, ensure that:**
 - Mechanical handling equipment is available, if required, for handling refrigerant cylinders.
 - All personal protective equipment is available and being used correctly
 - Isolate the system electrically.
 - The recovery process is always supervised by a competent person.
 - Recovery equipment and cylinders conform to the appropriate standards.



- When transferring refrigerant into cylinders, ensure that only appropriate refrigerant recovery cylinders are employed. Ensure that the cylinder is sized correctly to hold the entire refrigerant charge. All cylinders to be used are designated for the recovered refrigerant and labeled for that refrigerant (i.e., special cylinders for the recovery of refrigerant). Cylinders shall be complete with pressure-relief valve and associated shut-off valves in good working order. Empty recovery cylinders are evacuated and, if possible, cooled before recovery occurs.
- Even after refrigerant recovery, some residual refrigerant can be left entrained with the refrigerant oil. Cut out the compressor and drain and dispose of the compressor oil. Compressor oils are to be removed, ensure that they have been evacuated to an acceptable level to make certain that **flammable refrigerant** does not remain within the lubricant. Dispose of compressor and compressor oil in compliance with national, state, and local codes and regulations.
- The recovered refrigerant shall be returned to the refrigerant supplier in the correct recovery cylinder, and the relevant waste transfer note arranged. Do not mix refrigerants in recovery units and especially not in cylinders.
- All doors and drawers of the unit being disposal must be completely removed from the unit to avoid the risk of child entrapment. Leave shelving in place so children cannot easily climb inside.
- Disposal of this product shall be in compliance with all federal, state, and local regulations.

Labeling

Equipment shall be labeled stating that it has been decommissioned and emptied of refrigerant. The label shall be dated and signed. For appliances containing **flammable refrigerant**, ensure that there are labels on the equipment stating the equipment contains **flammable refrigerant**.

T H E
PERLICK[®]
C O R P O R A T I O N

8300 W Good Hope Rd

Milwaukee

Milwaukee, WI 53223