

KM 3465 G

Gas cooktop

with a dual wok burner for particularly wide ranging burner capacity.



- Simple controls -single-handed operation via rotary dial control
- Professional design – 30 (762) in (mm) wide stainless steel trough
- Particularly versatile – 4 burners incl. 1 dual wok
- Easy cleaning – ComfortClean dishwasher-safe grates

EAN: 4002514141008 / Material number: 06792700 / Old Material Number: 26346550USA

Heating type	
Fuel type	Gas
Construction type	
Independent of oven	•
Design	
Cast iron pot rests (matte black enameled)	•
Ring features	
No. of rings	4
1st cooking zone/cooking area	
Position	front left
Type	Dual wok burner
Max. rating in W	4500
2nd cooking zone/cooking area	
Position	rear left
Type	Standard burner
Max. rating in W	2600
3rd cooking zone/cooking area	
Position	rear right
Type	High-speed burner
Max. rating in W	3500
4th cooking zone/cooking area	
Position	front right
Type	Standard burner
Max. rating in W	2600
Control panel	
Operation via knobs	•
Electronic ignition with one-handed operation	•
QuickStart	•
Safety	
GasStop & ReStart	•
Technical data	
Dimensions (width) in in. (mm)	30 (762)
Dimensions (height) in in. (mm)	5 (125)
Depth in in. (mm)	21 3/8 (542)
Cutout dimensions in mm (width) with surface-mounted installation	28 3/8 (720)
Cutout dimensions in mm (depth) with surface-mounted installation	20 1/2 (518)
Weight in lbs. (kg)	41 (19)
Total connected load in kW	13.20
Power cord length in in. (m)	3 (1.2)
Voltage in V	120
Frequency in Hz	60
Accessories supplied	
Number of mains cables with plug	No

KM 3465 G

Gas cooktop

with a dual wok burner for particularly wide ranging burner capacity.

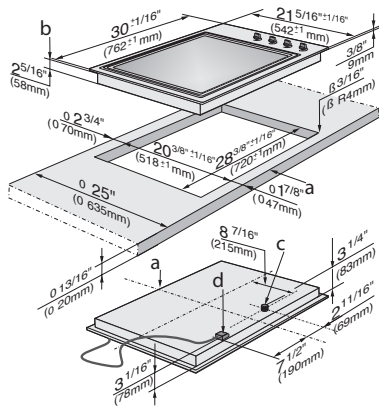

KM 3464/KM3565 (USA) (Installation drawing)

1. Front, 2. Installation height, 3. Gas connection, 4. Electrical connection