



Service Manual

EUR27A

EUR48A

EU27A

EU48A

⚠ WARNING

Only qualified service technicians should install and service the appliance. To obtain the name and phone number of your local Certified Service Representative, visit www.economyseries.com. No service should be undertaken until the technician has thoroughly read this Service Manual. Failure to service and maintain the appliance in accordance with this manual will adversely affect safety, performance, component life, and warranty coverage. Proper installation is the responsibility of the installer. Product failure or property damage due to improper installation is not covered under warranty.

This manual is provided primarily to assist qualified service technicians in the service of this appliance.

Should the reader have any questions or concerns which have not been satisfactorily addressed, please call, send an e-mail message, or write to the Technical Support Department for assistance.

Phone: (800) 227-3172

E-mail: techsupport@economyseries.com

ECONOMY SERIES

618 Highway 74 South

Peachtree City, GA 30269

Attn: Technical Support Department

Web Site: www.economyseries.com

NOTE: To expedite assistance, all correspondence/communication **MUST** include the following information:

- Model Number _____
- Serial Number _____
- Complete and detailed explanation of the problem.

IMPORTANT

This manual should be read carefully before the appliance is serviced. Read the warnings and guidelines contained in this booklet carefully as they provide essential information for the continued safe use, service, and maintenance of the appliance. Retain this booklet for any further reference that may be necessary.

Contents

Important Safety Information	4
I. General Information	7
A. Construction	7
B. Refrigeration Circuit.....	8
II. Sequence of Operation and Service Diagnosis	9
A. Sequence Flow Chart	9
1. Refrigerator	9
2. Freezer	10
B. Service Diagnosis	11
1. Troubleshooting	13
C. Control Module Check.....	16
D. Thermistor Check	17
E. Temperature Setting Dial (EUR)	18
F. Temperature Setting Dial (EUF)	18
G. Description of Control Module Label.....	18
III. Refrigeration Circuit and Component Service Information	19
A. Service for Refrigerant Lines.....	21
B. Maintenance.....	24
1. Condenser	24
2. Power Supply Connection	24
IV. Preparing the Appliance for Periods of Non-Use	25
V. Disposal	26
VI. Technical Information.....	27
A. Electrical and Refrigerant Data	27
B. Wiring Diagram.....	28

Important Safety Information

Throughout this manual, notices appear to bring your attention to situations which could result in death, serious injury, damage to the appliance, or damage to property.

⚠ DANGER	Indicates a hazardous situation that, if not avoided, will result in death or serious injury.
⚠ WARNING	Indicates a hazardous situation that, if not avoided, could result in death or serious injury.
NOTICE	Indicates a situation that, if not avoided, could result in damage to the appliance or property.
IMPORTANT	Indicates important information about the use and care of the appliance.

⚠ DANGER
<p><u>Risk of Fire or Explosion</u></p> <p><u>Flammable Refrigerant Used</u></p> <ul style="list-style-type: none"> • Follow handling instructions carefully in compliance with U.S. government regulations. • Do not use mechanical devices to defrost. • Do not puncture refrigerant tubing. Risk of fire or explosion due to puncture of refrigerant tubing; follow handling instructions carefully. • Component parts shall be replaced with like components. • Servicing shall be done by factory authorized service personnel to minimize the risk of possible ignition due to incorrect parts or improper service. • Consult instruction manual / service manual before attempting to install or service this product. All safety precautions must be followed. • Dispose of properly in accordance with federal or local regulations. • Do not place any potential ignition sources in or near the appliance.

<p><u>Risque De Feu Ou D'Explosion</u></p> <p><u>Le Frigorigène Est Inflammable</u></p> <ul style="list-style-type: none"> • Suivre attentivement les instructions de manipulation conformément à la réglementation gouvernementale. • Ne pas utiliser d'appareils mécaniques pour dégivrer le réfrigérateur. • Ne pas perforer la tubulure contenant le frigorigène. Risque de feu ou d'explosion si la tubulure contenant le frigorigène est perforée; suivre les instructions de manutention avec soin. • Les pièces des composants doivent être remplacées par des pièces et accessoires équivalents. • L'entretien doit être effectué par le personnel de service autorisé par le fabricant afin de minimiser les risques d'inflammation attribuables à l'installation d'une pièce inadéquate ou à la mauvaise exécution du service. • Consulter le manuel du propriétaire/ guide de réparation avant de tenter une réparation. Toutes les mesures de sécurité doivent être respectées. • Éliminer conformément aux règlements fédéraux ou locaux. • Ne placez aucune source d'inflammation potentielle dans ou près de l'appareil.
--

WARNING

This appliance should be destined only to the use for which it has been expressly conceived. Any other use should be considered improper and therefore dangerous. The manufacturer cannot be held responsible for injury or damage resulting from improper, incorrect, and unreasonable use. Failure to install, operate, and maintain the appliance in accordance with this manual will adversely affect safety, performance, component life, and warranty coverage.

To reduce the risk of death, electric shock, serious injury, or fire, follow basic precautions including the following:

- Only qualified service technicians should install and service this appliance.
- Wear appropriate personal protective equipment (PPE) when servicing the appliance.
- The appliance must be installed in accordance with applicable national, state, and local codes and regulations.
- Appliance is heavy. Use care when lifting or positioning. Work in pairs when needed to prevent injury or damage.
- The appliance requires an independent power supply of proper capacity. See the nameplate for electrical specifications. Failure to use an independent power supply of proper capacity can result in a tripped breaker, blown fuse, or damage to existing wiring. This could lead to heat generation or fire.
- To reduce the risk of electric shock, do not touch the plug with damp hands.
- Unplug the appliance from the electrical outlet.
- **THE APPLIANCE MUST BE GROUNDED:** The appliance is equipped with a NEMA 5-15 three-prong grounding plug  to reduce the risk of potential shock hazards. It must be plugged into a properly grounded, independent 3-prong wall outlet. If the outlet is a 2-prong outlet, it is your personal responsibility to have a qualified electrician replace it with a properly grounded, independent 3-prong wall outlet. Do not remove the ground prong from the plug and do not use an adapter plug. Failure to follow these instructions may result in death, electric shock, or fire.
- The GREEN ground wire in the factory-installed power cord is connected to the appliance. If it becomes necessary to remove or replace the power cord, be sure to connect the power cord's ground wire.
- Do not use an extension cord.
- Do not use an appliance with a damaged power cord. The power cord should not be altered, jerked, bundled, weighed down, pinched, or tangled. Such actions could result in electric shock or fire. To unplug the appliance, be sure to pull the plug, not the cord, and do not jerk the cord.
- Do not splash, pour, or spray water directly onto or into the appliance. This might cause short circuit, electric shock, corrosion, or failure.
- Do not make any alterations to the appliance. Alterations could result in electric shock, injury, fire, or damage to the appliance.

⚠ WARNING, continued

- The appliance is not intended for use by persons (including children) with reduced physical, sensory, or mental capabilities, or lack of experience and knowledge, unless they have been given supervision or instruction concerning use of the appliance by a person responsible for their safety.
- Children should be properly supervised around the appliance.
- Do not climb, stand, or hang on the appliance or door or allow children or animals to do so. Do not climb into the appliance or allow children or animals to do so. Death or serious injury could occur or the appliance could be damaged.
- Be careful not to pinch fingers when opening and closing the door. Be careful when opening and closing the door when children are in the area.
- Open and close the doors with care. Doors opened too quickly or forcefully may cause injury or damage to the appliance or surrounding equipment.
- Do not use combustible spray or place volatile or flammable substances near the appliance. They might catch fire.
- Keep the area around the appliance clean. Dirt, dust, or insects in the appliance could cause harm to individuals or damage to the appliance.
- Do not place anything on top of the appliance. Foreign objects or moisture could enter the appliance and result in electric shock or fire.
- Do not block air inlets or outlets, otherwise cooling performance may be reduced.
- Do not tightly pack the cabinet. Allow some space between items to ensure good air flow. Also allow space between items and interior surfaces.
- Do not store items near the air outlet. They might freeze up and crack or break causing a risk of injury or contamination of other food.

NOTICE

- Protect the floor when moving the appliance to prevent damage to the floor.
- Keep ventilation openings, in the appliance enclosure or in the built-in structure, clear of obstruction. Do not place anything on top of the appliance. Blockage of airflow could negatively affect performance and damage the appliance.
- To prevent deformation or cracks, do not spray insecticide onto the plastic parts or let them come into contact with oil.
- To avoid damage to the gasket, use only the door handle when opening and closing.

I. General Information

A. Construction



B. Refrigeration Circuit

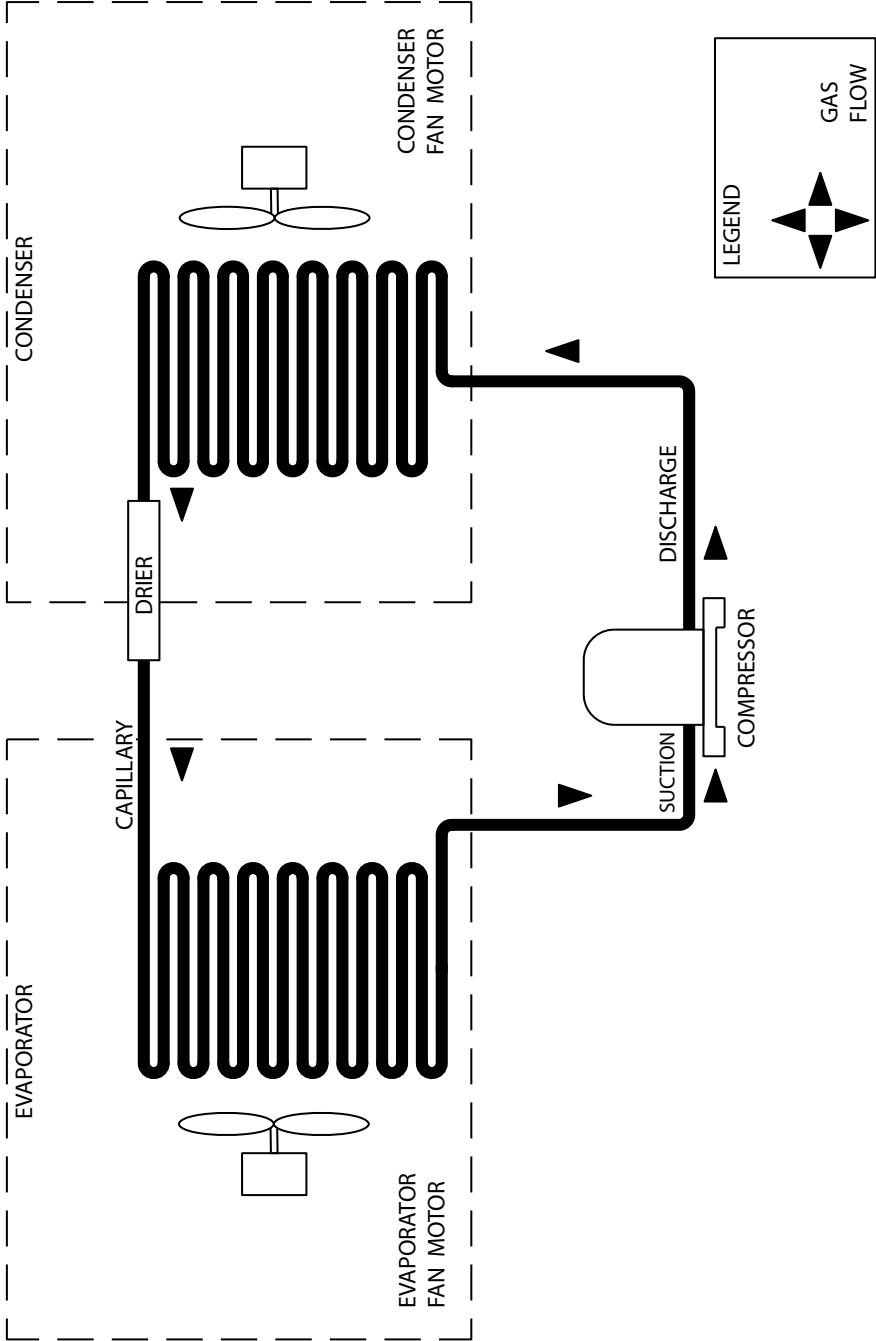

II. Sequence of Operation and Service Diagnosis

A. Sequence Flow Chart

1. Refrigerator

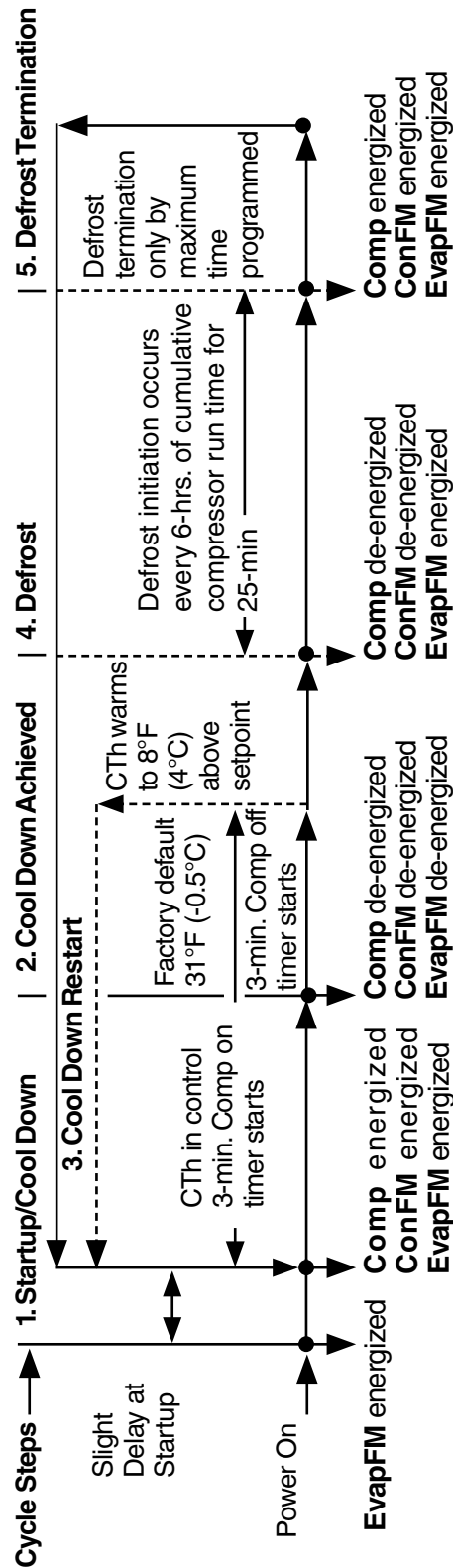

Note:

- a) 3-min. minimum Comp on timer starts when Comp energizes.
- b) 3-min. minimum Comp off timer starts when Comp de-energizes.
- c) 25-min. maximum defrost time.

Legend:

Comp-compressor
ConFM-condenser fan motor
CTh-cabinet thermistor
EvapFM-evaporator fan motor

2. Freezer

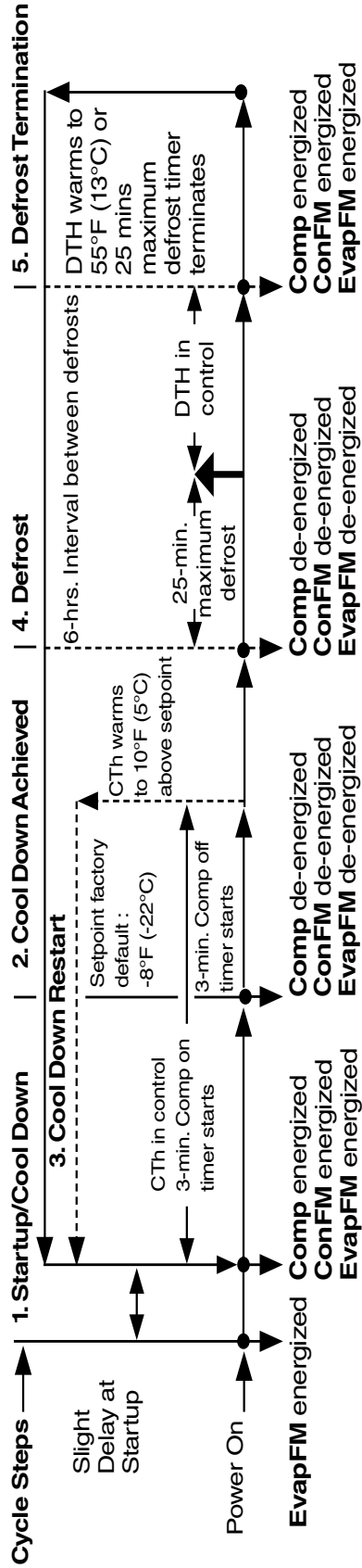

Note:

- a) 3-min. minimum Comp on timer starts when Comp energizes.
- b) 3-min. minimum Comp off timer starts when Comp de-energizes.
- c) 25-min. maximum defrost time.

Legend:

- Comp-compressor
- ConFM-condenser fan motor
- CTh-cabinet thermistor
- DTh-defrost thermistor
- EvapFM-evaporator fan motor

B. Service Diagnosis

DANGER

Risk of Fire or Explosion

Flammable Refrigerant Used

- Follow handling instructions carefully in compliance with U.S. government regulations.
- Do not use mechanical devices to defrost.
- Do not puncture refrigerant tubing. Risk of fire or explosion due to puncture of refrigerant tubing; follow handling instructions carefully.
- Component parts shall be replaced with like components.
- Servicing shall be done by factory authorized service personnel to minimize the risk of possible ignition due to incorrect parts or improper service.
- Consult instruction manual/service manual before attempting to install or service this product. All safety precautions must be followed.
- Dispose of properly in accordance with federal or local regulations.
- Do not place any potential ignition sources in or near the appliance.

Risque De Feu Ou D'Explosion

Le Frigorigène Est Inflammable

- Suivre attentivement les instructions de manipulation conformément à la réglementation gouvernementale.
- Ne pas utiliser d'appareils mécaniques pour dégivrer le réfrigérateur.
- Ne pas perforer la tubulure contenant le frigorigène. Risque de feu ou d'explosion si la tubulure contenant le frigorigène est perforée; suivre les instructions de manutention avec soin.
- Les pièces des composants doivent être remplacées par des pièces et accessoires équivalents.
- L'entretien doit être effectué par le personnel de service autorisé par le fabricant afin de minimiser les risques d'inflammation attribuables à l'installation d'une pièce inadéquate ou à la mauvaise exécution du service.
- Consulter le manuel du propriétaire/ guide de réparation avant de tenter une réparation. Toutes les mesures de sécurité doivent être respectées.
- Éliminer conformément aux règlements fédéraux ou locaux.
- Ne placez aucune source d'inflammation potentielle dans ou près de l'appareil.

WARNING

- This appliance should be diagnosed and repaired only by qualified service personnel to reduce the risk of death, electric shock, serious injury, or fire.
- Risk of electric shock. Use extreme caution and exercise safe electrical practices.
- Moving parts (e.g. fan blade) can crush and cut. Keep hands clear.
- Make sure all food zones are clean after the appliance is serviced.

NOTICE

- Normal operating ambient temperature range is from 45°F to 100°F (7°C to 38°C).
- Ventilation is required from the bottom front of the appliance. Keep this area open and clear of any obstructions. Adjacent cabinets and counter top can be installed around the appliance as long as the front grille remains unobstructed.
- The appliance must not be located next to ovens, grills, or other high heat producing equipment.
- The appliance must not be located in a corrosive environment.

The diagnostic table is a sequence check that allows you to diagnose the electrical system and components. Before proceeding, check for correct installation and proper voltage per nameplate. Always choose a neutral (W) to establish a good neutral connection when checking high voltages.

IMPORTANT

The maximum allowable voltage variation is ± 10 percent of the nameplate rating. 115VAC is used as a reference voltage when checking voltage to components. Voltage may vary depending on power supply.

Factory Default Temperature Setpoint:

- For EUR27A and EUR48A is 31°F (-0.5°C)
- For EUF27A and EUF48A is -8°F (-22°C)

Temperature Display Scale: °F (-°C)

- There is a minimum 3-min. Comp on time and 3-min. Comp off time.

1. Troubleshooting

Check for correct appliance installation per the instruction manual and proper voltage per appliance nameplate.

a) Not Cooling

Not Cooling - Possible Cause	
1. Power Supply	a) Unplugged, off, blown fuse, tripped or defective circuit breaker. On three-section receptacle box, only top receptacles have power.
	b) Loose connection.
	c) Not within specifications.
2. Cord and Plug	a) Loose connection.
	b) Defective.
3. Control Module See "II.B.1.g) Alarm Safeties" and "II.C. Control Module Check"	a) In alarm.
	b) Defective.
4. Door Switch	a) Not engaged.
	b) Defective.
5. Door Switch Relay	a) Loose connection.
	b) Defective.
6. Fan Motors	a) Defective.
	b) Dirty condenser.
7. Wiring	a) Loose connection.
	b) Faulty.
8. Compressor Relay (ptc)	a) Defective.
9. Compressor External Protector	a) Dirty condenser.
	b) Condenser fan motor not operating.
	c) Compressor capacitor or start relay defective.
	d) Defective.
10. Compressor	a) Defective.
	b) Low voltage.
11. Condenser	a) Dirty.
12. Refrigerant/Refrigerant Lines	a) Low or overcharged.
	b) Refrigerant leak.
	c) Refrigerant lines restricted.
13. Filter Drier	a) Defective.

b) Too Much Cooling

Too much cooling - Possible Cause	
1. Cabinet Thermistor	a) Defective.

c) Extreme Condensation

Extreme condensation - Possible Cause	
1. Cabinet Thermistor	a) Loose.
	b) Installed improperly.
2. Door	a) Do not shut completely (Defective gasket or hinges not adjusted).
3. Location	a) Inadequate location.
4. Environment	a) High relative humidity (Over 75%).

d) Evaporator Frozen Up

Evaporator Frozen Up - Possible Cause	
1. Evaporator	a) Dirty.
2. Evaporator Fan Motor	a) Fan blades binding.
	b) Defective.
3. Control Module	a) Defective.
4. Compressor Relay (ptc)	a) Defective.
5. Refrigerant Charge/Refrigerant Lines	a) Low.
	b) Component restriction (cap tube or drier).

e) Defrost

Refrigerator Defrost Fails to Initiate - Possible Cause	
1. Control Module (6-hrs. defrost timer)	a) Defective.

f) No Illumination

No illumination - Possible Cause	
1. Light Switch	a) "OFF" position.
	b) Open contact.
	c) Defective.
2. Control Module	a) Control Module program.

g) Alarm Safeties

R	LEDS			Mains Voltage on	Compressor on	Description
	Y	G				
●	○	○		✓	✗	Off.Voltage bad (too high or too low).
○	●	○		✓	✗	Wait period. (Intelligent Time Delay). Allows neutralisation of refrigerant pressure.
○	○	●		✓	✓	On. Voltage good. No wait time. Cooling demand.
●	○	●		✓	✗	Defrost Period. Starts after 6 hours of accumulated compressor run time for 25 minutes.
⊗	○	○		✗	✗	No cool demand (NCD). Voltage is bad.
○	⊗	○		✓	✗	No cool demand (NCD). Wait is on.
○	○	⊗		✓	✗	No cool demand (NCD). In cut-out zone.
⊗	⊗	⊗		△		Test mode. If in the No cool demand (NCD), this forces compressor to go on for 10 seconds.
○	⊗	⊗		△	✗	Probe fault. Normally compressor shuts down unless specified by customer to cycle with pre-determined time sequence.
⊗	⊗	○		△	✗	Fault. Mains sense auto recovery possible.
⊖	⊖	⊖		△	✗	Knob in off position.

KEY ✓ On/good ✗ Off/bad △ Not relevant ⊗ Flashing ⊖ Cycling ○ Off ● On

C. Control Module Check

1. Control Module Display. Before replacing CM that does not show a visible defect and that you suspect is bad, conduct the following check procedure. This procedure will help you verify your diagnosis. Always choose a neutral (W) to establish a good neutral connection when checking high voltages. Also, confirm there is a good power supply and neutral connection to CM: 115VAC.
2. Startup/Cool Down.
3. Check all wiring connections. Confirm the CTh is properly connected.
4. Check for 115VAC to neutral. If 115VAC is not present, check power supply, and wire connections.
5. Make sure doors are closed. Next, check for 115VAC to neutral. If 115VAC is not present, replace CM.
6. Check that Comp and ConFM energize. If not, check CTh status. See “II.D. Thermistor Check.” If CTh ohm reading is in proper range, check for 115VAC at CM to neutral. If 115VAC is not present, replace CM.
7. Defrost Initiation (EUR). Defrost initiation by 6 hours compressor cumulative run time. Confirm Comp and ConFM de-energize, EvapFM continues on. Check for 115VAC at CM to neutral for Comp and ConFM, then at CM to neutral for EvapFM.
8. Defrost Initiation (EUF). Defrost initiation by 6 hours compressor cumulative run time. Confirm Comp and ConFM de-energize, EvapFM de-energize. Check for 115VAC at CM to neutral for Comp and ConFM, then at CM to neutral for EvapFM.

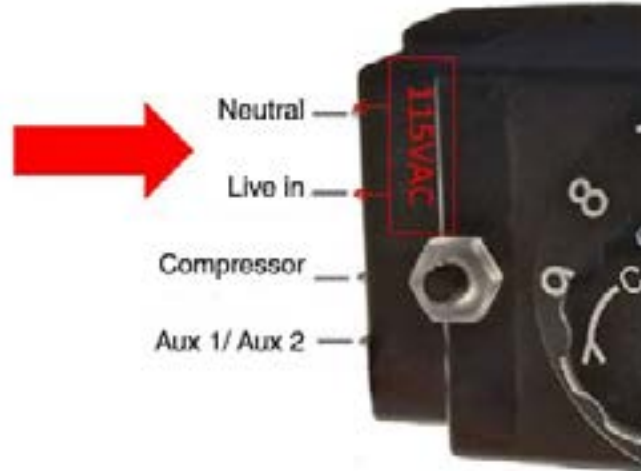

9. Defrost Termination (EUR). Check after a 25 min. that the Comp turn on again.
10. Defrost Termination (EUF). Ends when evaporator temperature reaches 55 °F or after 25 minutes, whichever comes first.

Legend: CM—control module; Comp—compressor; ConFM—condenser fan motor; CTh—cabinet thermistor; DS—door switch; DTh—defrost thermistor; EvapFM—evaporator fan motors, MH—mullion heater; PH—perimeter heater.

D. Thermistor Check

The cabinet thermistor is used for cabinet temperature control. Thermistor resistance varies depending on temperature. The control module monitors the thermistors to control system operation. No adjustment is required.

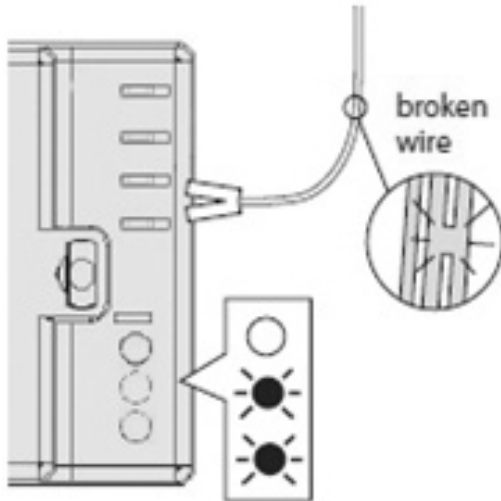

Defrost initiation occurs every 6 hrs. of cumulative compressor run time with a maximum duration of 25-min.

To check thermistor resistance, follow the steps below:

1. Unplug the appliance from the electrical outlet.
2. Remove the control cover.
3. Disconnect and remove the thermistor in question.
4. Immerse the thermistor sensor portion in a glass containing ice and water for 2 to 3 min.
5. Check the resistance between the wires at the thermistor connector. Normal reading is within 272 to 282 k Ω . If outside the normal reading, replace the thermistor.
6. Reconnect and replace the thermistor in its correct position.
7. Plug the appliance back into the electrical outlet.

E. Temperature Setting Dial (EUR)

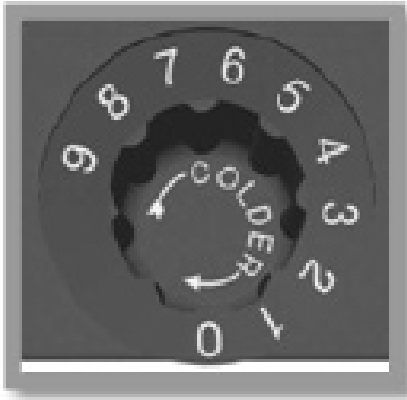

Marking 1 Cut-In/Cut-out:	41.0	▼	33.1	▼
Marking 2 Cut-In/Cut-out:	40.5	▼	32.5	▼
Marking 3 Cut-In/Cut-out:	39.9	▼	32.0	▼
Marking 4 Cut-In/Cut-out:	39.6	▼	31.5	▼
Marking 5 Cut-In/Cut-out:	39.0	▼	30.9	▼
Marking 6 Cut-In/Cut-out:	38.5	▼	30.6	▼
Marking 7 Cut-In/Cut-out:	37.9	▼	30.0	▼
Marking 8 Cut-In/Cut-out:	37.6	▼	29.5	▼
Marking 9 Cut-In/Cut-out:	37.0	▼	28.9	▼

F. Temperature Setting Dial (EUF)

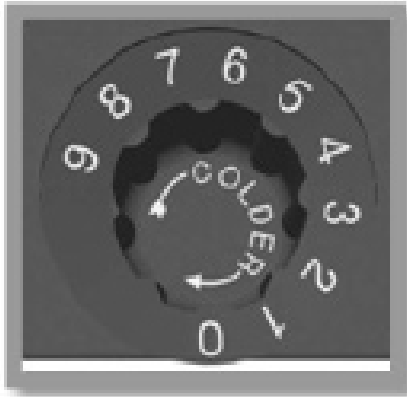

Marking 1 Cut-In/Cut-out:	6.0	▼	-4.0	▼
Marking 2 Cut-In/Cut-out:	5.0	▼	-5.0	▼
Marking 3 Cut-In/Cut-out:	4.0	▼	-6.0	▼
Marking 4 Cut-In/Cut-out:	3.0	▼	-7.0	▼
Marking 5 Cut-In/Cut-out:	2.0	▼	-8.0	▼
Marking 6 Cut-In/Cut-out:	1.0	▼	-9.0	▼
Marking 7 Cut-In/Cut-out:	0.0	▼	-10.0	▼
Marking 8 Cut-In/Cut-out:	-1.0	▼	-11.0	▼
Marking 9 Cut-In/Cut-out:	-2.0	▼	-12.0	▼

G. Description of Control Module Label

Each control module has a decal with the following information:

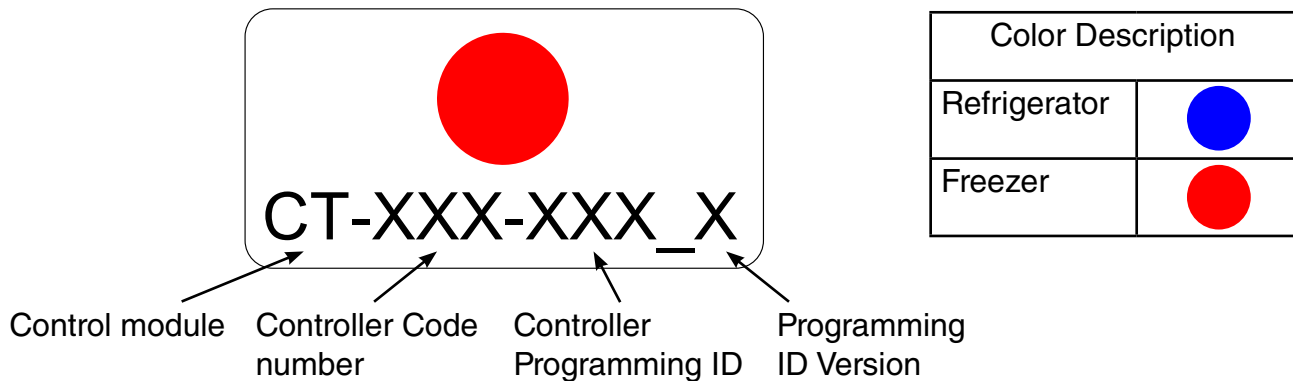

III. Refrigeration Circuit and Component Service Information

⚠ DANGER

Risk of Fire or Explosion Flammable Refrigerant Used

- Follow handling instructions carefully in compliance with U.S. government regulations.
- Do not use mechanical devices to defrost.
- Do not puncture refrigerant tubing. Risk of fire or explosion due to puncture of refrigerant tubing; follow handling instructions carefully.
- Component parts shall be replaced with like components.
- Servicing shall be done by factory authorized service personnel to minimize the risk of possible ignition due to incorrect parts or improper service.
- Consult instruction manual/service manual before attempting to install or service this product.
- Dispose of properly in accordance with federal or local regulations.
- Do not place any potential ignition sources in or near the appliance.

Risque De Feu Ou D'Explosion Le Frigorigène Est Inflammable

- Suivre attentivement les instructions de manipulation conformément à la réglementation gouvernementale.
- Ne pas utiliser d'appareils mécaniques pour dégivrer le réfrigérateur.
- Ne pas perforer la tubulure contenant le frigorigène. Risque de feu ou d'explosion si la tubulure contenant le frigorigène est perforée; suivre les instructions de manutention avec soin.
- Les pièces des composants doivent être remplacées par des pièces et accessoires équivalents.
- L'entretien doit être effectué par le personnel de service autorisé par le fabricant afin de minimiser les risques d'inflammation attribuables à l'installation d'une pièce inadéquate ou à la mauvaise exécution du service.
- Consulter le manuel du propriétaire/guide de réparation avant de tenter une réparation. Toutes les mesures de sécurité doivent être respectées.
- Éliminer conformément aux règlements fédéraux ou locaux.
- Ne placez aucune source d'inflammation potentielle dans ou près de l'appareil.

⚠ WARNING

- Wear appropriate personal protective equipment (PPE) when servicing the appliance.
- Technician must utilize a combustible gas leak detector at all times.
- Notify everyone in the immediate area that you are working with flammable refrigerant.
- Do not work on appliance in a confined space. Confirm area is well ventilated.
- Identify and eliminate all possible ignition points in a 10 ft. (3 m) area around service area.
- Do not use mechanical devices to defrost.
- Use non-sparking tools.
- Class B dry chemical fire extinguisher or equivalent must be available.
- Do not pressurize system above 200 PSIG during leak check procedure or prior to evacuating refrigeration system.
- This appliance should be diagnosed and repaired only by qualified service personnel to reduce the risk of death, electric shock, serious injury, or fire.
- To reduce the risk of electric shock, do not touch the plug with damp hands.
- Unplug the appliance from the electrical outlet before servicing.
- Make sure all food zones in the appliance are clean after the appliance is serviced.

A. Service for Refrigerant Lines

WARNING

- Repairs requiring the refrigeration circuit to be opened must be performed by properly trained and EPA-certified service personnel.
- Use an electronic leak detector or soap bubbles to check for leaks. Add a trace of refrigerant to the system (if using an electronic leak detector), and then raise the pressure using nitrogen gas (140 PSIG). Do not use R-290 as a mixture with pressurized air for leak testing.

NOTICE

- Always recover the refrigerant and store it in an approved container. Do not discharge the refrigerant into the atmosphere.
- Do not leave the system open for longer than 15 minutes when replacing or servicing parts. The Polyol Ester (POE) oils used in R-290 appliances can absorb moisture quickly. Therefore it is important to prevent moisture from entering the system when replacing or servicing parts.
- Always install a new drier every time the sealed refrigeration system is opened. Do not replace the drier until after all other repair or replacement has been made. Install the new drier with the arrow on the drier in the direction of the refrigerant flow.
- When brazing, protect the drier by using a wet cloth to prevent the drier from overheating. Do not allow the drier to exceed 250°F (121°C).

Refrigerant leaks must be repaired as soon as they are discovered. If not, refrigerant charge should be recovered from the system until the leak can be repaired.

When repairing a leak:

- Repair the leak properly – Remove the refrigerant, examine the leak source, determine the reason for the leak, and carry out the proper course of action.
- Before repairing the leak, ensure that the refrigerant has been recovered and the system purged with nitrogen when brazing.
- Be sure to remove piercing valves attached to the system after repairs are made.

1. Refrigerant Recovery

Using proper refrigerant practices, place piercing valves toward the end (crimped area) of the high and low-side process tubes, then recover the refrigerant into an approved container or device.

2. Brazing

⚠ DANGER

Risk of Fire or Explosion Flammable Refrigerant Used

- Servicing shall be done by factory authorized service personnel to minimize the risk of possible ignition due to incorrect parts or improper service.

Risque De Feu Ou D'Explosion Le Frigorigène Est Inflammable

- L'entretien doit être effectué par le personnel de service autorisé par le fabricant afin de minimiser les risques d'inflammation attribuables à l'installation d'une pièce inadéquate ou à la mauvaise exécution du service.

⚠ WARNING

- Wear appropriate personal protective equipment (PPE) when servicing the appliance.
- You must have a combustible gas leak detector in the immediate work area at all times.
- You must have a Class B chemical fire extinguisher available at all times.
- Notify all persons in the immediate area that you are working with a flammable refrigerant.
- Do not use silver alloy or copper alloy containing arsenic.
- Be sure the area is clear of refrigerant vapor before brazing.

- 1) Purge with nitrogen for 2 min. **WARNING! Purging with nitrogen gas assures all refrigerant has been removed from the refrigeration circuit.**
- 2) Braze/repair/replace damaged component or fittings while purging with nitrogen gas flowing at a pressure of 3 to 5 PSIG.

NOTICE

- Always install a new drier every time the sealed refrigeration system is opened.
- Do not replace the drier until after all other repair or replacement has been made. Install the new drier with the arrow on the drier in the direction of the refrigerant flow.
- When brazing, protect the drier by using a wet cloth to prevent the drier from overheating. Do not allow the drier to exceed 250°F (121°C).

- 3) Use soap bubbles to check for leaks. Raise the pressure using nitrogen gas (190 PSIG). Do not use any refrigerant as a mixture with pressurized air for leak testing.
- 4) Once leak checking is complete, release the nitrogen gas from the system.

3. Evacuation

- 1) Attach a vacuum pump to the system. Be sure to connect the charging hoses to both high and low-side refrigerant piercing valves.

<i>IMPORTANT</i>
The vacuum level and vacuum pump may be the same as those for current refrigerants. However, the rubber hose and gauge manifold to be used for evacuation and refrigerant charge should be exclusively for POE oils.

- 2) Turn on the vacuum pump, then open the gauge manifold valves. Never allow the oil in the vacuum pump to flow backwards.
- 3) Allow the vacuum pump to pull down to a 29.9" Hg vacuum (500 microns). Evacuating period depends on pump capacity.
- 4) Close the low-side valve and high-side valve on the gauge manifold.
- 5) Disconnect the gauge manifold hose from the vacuum pump and attach it to a refrigerant service cylinder. Remember to loosen the connection and purge the air from the hose. For the required refrigerant charge, see the nameplate. We recommend only virgin or reclaimed refrigerant which meets ARI Standard 700 (latest edition) be used.

4. Recharge

- 6) R-290 can be charged in either the liquid or vapor state. A liquid charge is preferred. Connect the refrigerant hose to the service cylinder and bleed air out of refrigerant hose. Next, invert the service cylinder and place it on the scales. Zero out the scales. Open the high-side valve on the gauge manifold.
- 7) Allow the system to charge with liquid until the proper charge weight is met.
- 8) Close the high-side valve on the gauge manifold. If charging is complete, skip to step 10.
- 9) If necessary, add any remaining charge to the system through the low-side.
NOTICE! To prevent compressor damage, use a throttling valve or liquid dispensing device to add the remaining liquid charge through the low-side refrigerant access valve with the compressor running. Close the refrigerant cylinder valve and let the low-side refrigerant equalize to the system, then close the low-side manifold gauge. Unplug the appliance from the electrical outlet.
- 10) Remove the refrigerant hose from the service cylinder. Pinch off (crimp down) the process tubes just below the piercing valves.
- 11) Remove the piercing valves. Cut the process tubes to remove the piercing valve holes then braze the process tubes closed. Note: Be sure there is no refrigerant leak or refrigerant in the area before brazing.
- 12) Use a combustible gas leak detector or soap bubbles to check for leaks again.
- 13) Place red sleeves over the process tubes.
- 14) Plug the appliance back into the electrical outlet. Allow the appliance to cool to setpoint before reloading.

B. Maintenance

⚠ WARNING

- | |
|---|
| <ul style="list-style-type: none">• Unplug the appliance before performing maintenance to prevent electric shock or injury by moving parts.• Before performing maintenance, move all foods into another clean refrigerator or freezer. |
|---|

1. Condenser

Check the condenser once a year and use a brush or vacuum cleaner to clean the condenser as required.

2. Power Supply Connection

If a plug, power cord, or receptacle is damaged, replace it. Be sure to connect the ground wire.

IV. Preparing the Appliance for Periods of Non-Use

⚠ WARNING

- When preparing the appliance for long storage, prevent the doors from closing to reduce the risk of children getting trapped.
- To reduce the risk of electric shock, do not touch the attachment plug with damp hands.
- When shutting down the appliance for more than one week, unplug the appliance.

NOTICE

- When preparing the appliance for long storage, clean the cabinet interior, door gaskets, and shelves.

1. Before shutting down the appliance, move the items into another refrigerator or freezer.
2. Unplug the appliance. **WARNING! To reduce the risk of electric shock, do not touch the plug with damp hands.**

V. Disposal

⚠ DANGER

Risk of Fire or Explosion Flammable Refrigerant Used

- Follow handling instructions carefully in compliance with U.S. government regulations.
- Do not puncture refrigerant tubing. Risk of fire or explosion due to puncture of refrigerant tubing; follow handling instructions carefully.
- Dispose of properly in accordance with federal or local regulations.

Risque De Feu Ou D'Explosion Le Frigorigène Est Inflammable

- Suivre attentivement les instructions de manipulation conformément à la réglementation gouvernementale.
- Ne pas perforer la tubulure contenant le frigorigène. Risque de feu ou d'explosion si la tubulure contenant le frigorigène est perforée; suivre les instructions de manutention avec soin.
- Éliminer conformément aux règlements fédéraux ou locaux.

⚠ WARNING

- When preparing the appliance for disposal, remove the door to reduce the risk of children getting trapped. Leave the shelves in place so that children may not easily climb inside.

The appliance contains refrigerant and must be disposed of in accordance with applicable national, state, and local codes and regulations. Refrigerant must be recovered by properly certified service personnel.

VI. Technical Information

We reserve the right to make changes in specifications and design without prior notice.

A. Electrical and Refrigerant Data

See the nameplate for electrical and refrigerant data. The nameplate is located inside the cabinet.

Electrical and Refrigerant Data					
Model	AC Supply Voltage	Amperes	Design Pressure (PSIG)		Refrigerant (oz.)
			HIGH	LOW	R-290
EUR27A	115/60/1	1.5	293	135	1.9
EUF27A	115/60/1	1.2	293	135	1.9
EUR48A	115/60/1	1.8	293	135	2.4
EUF48A	115/60/1	1.7	293	135	2.3

B. Wiring Diagram

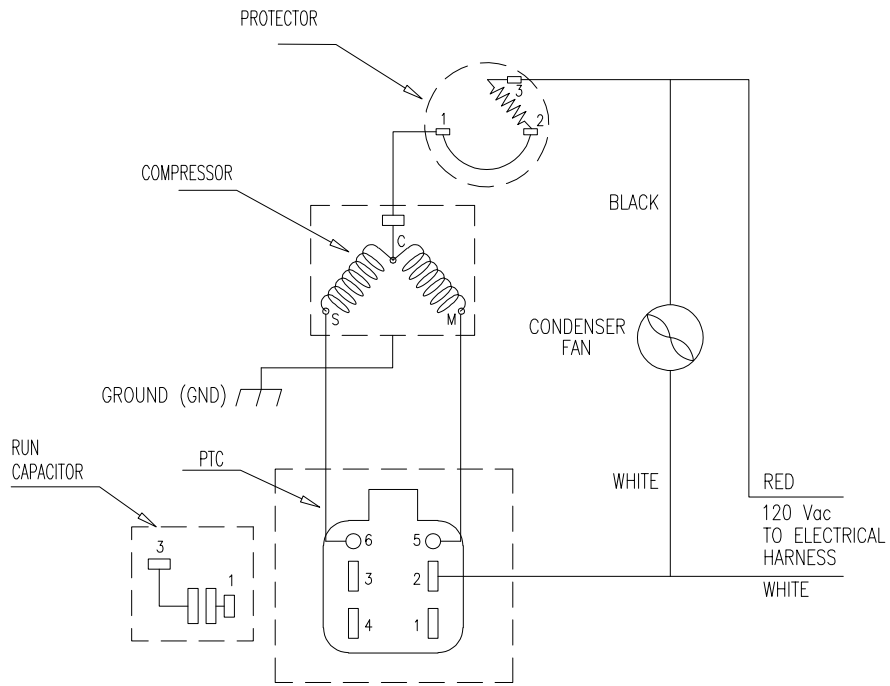
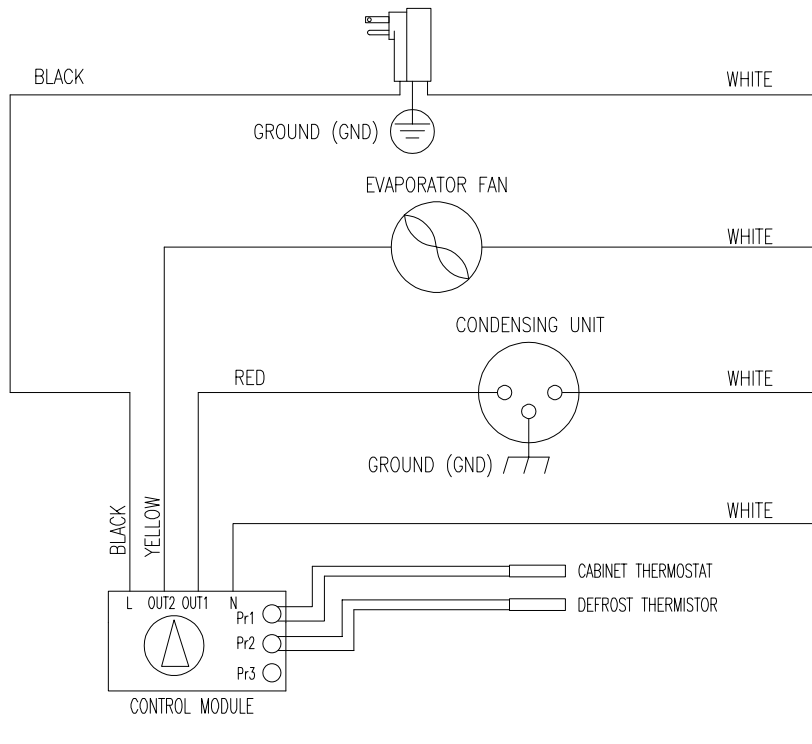

DETAIL

CONNECTIONS FOR EM2U3111U COMPRESSOR

Model	Run Capacitor	Starting Capacitor
EUR27A	12 μ F 180 V	it does not use

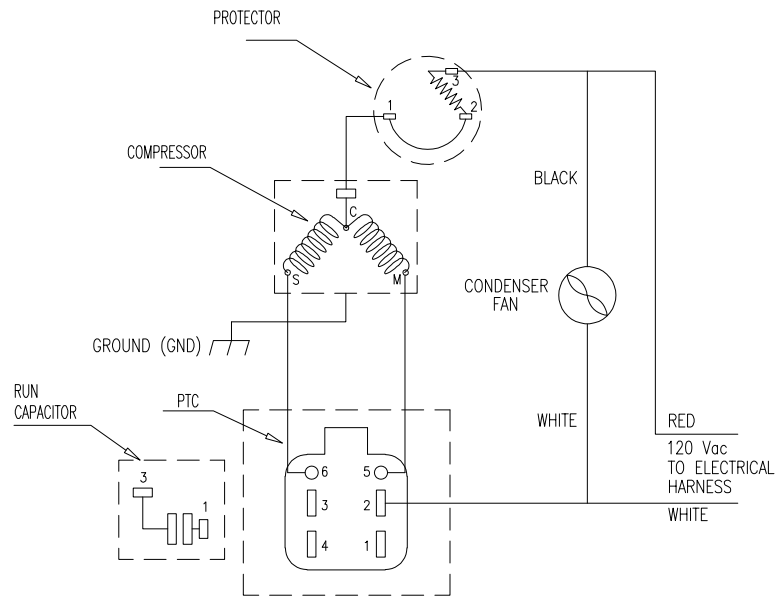
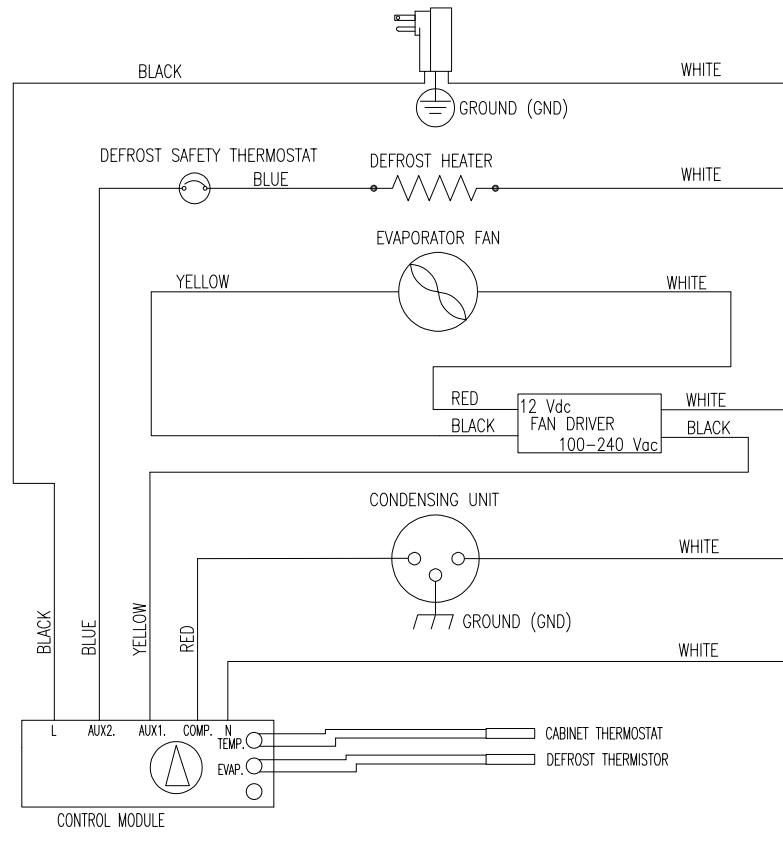

DETAIL
CONNECTIONS FOR EM2U3115U COMPRESSOR

Model	Run Capacitor	Starting Capacitor
EUF27A	12 μ F 180 V	it does not use

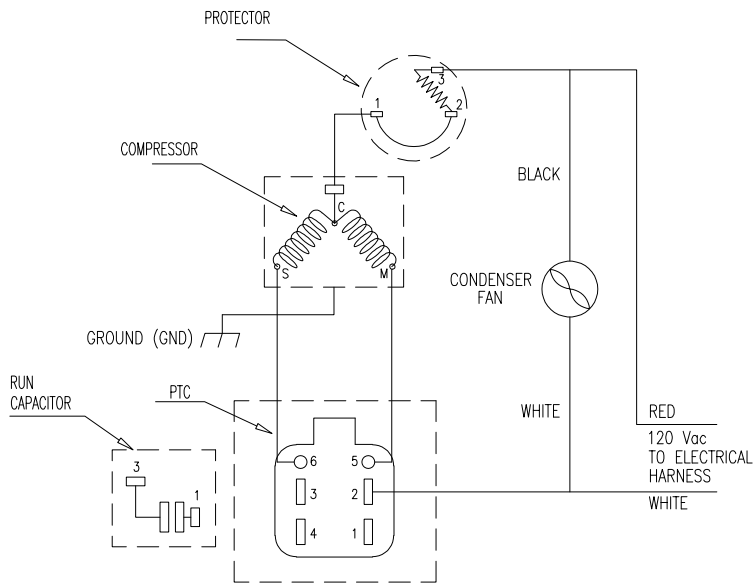
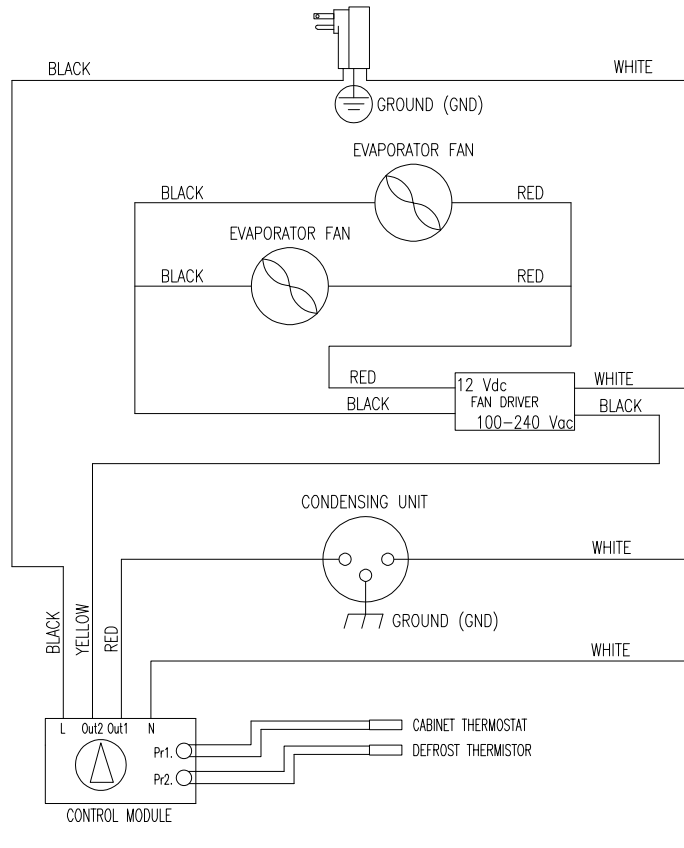

DETAIL
CONNECTIONS FOR EM2U3111U COMPRESSOR

Model	Run Capacitor	Starting Capacitor
EUR48A	12 μ F 180 V	it does not use

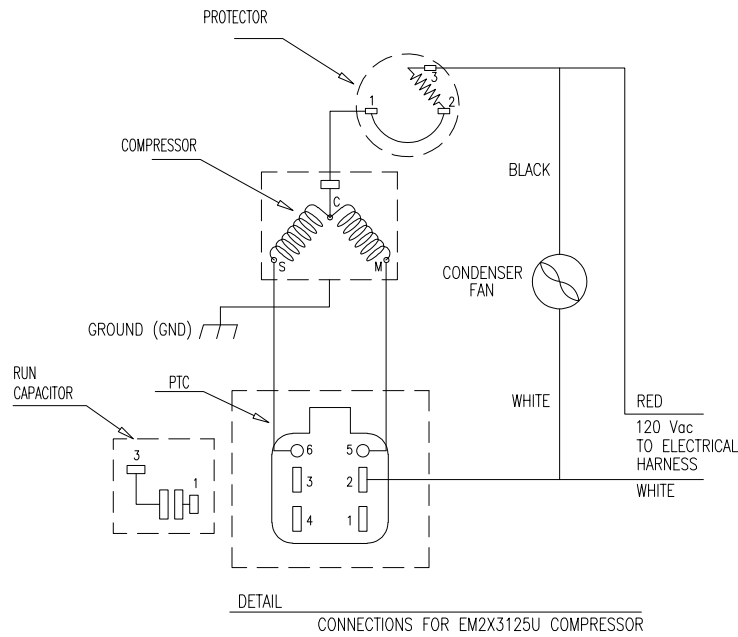
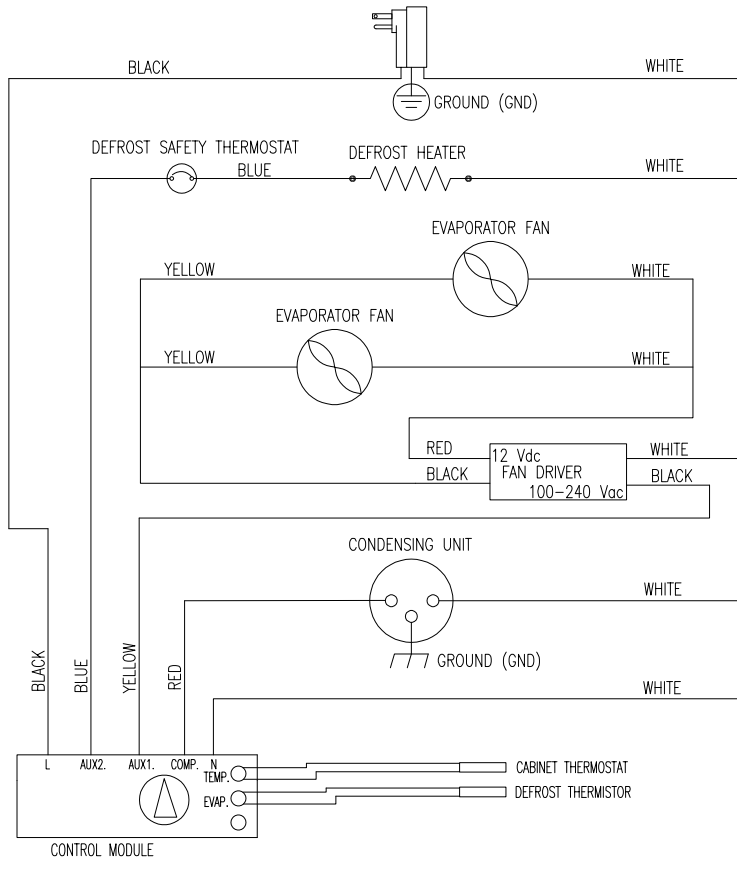

Model	Run Capacitor	Starting Capacitor
EUF48A	20 μ F 180 V	it does not use